

エア軸受タービンスピンドル / Air Bearing Turbine Spindle

ABT - 1000

取扱説明書 / OPERATION MANUAL

日本語 : P1 - P26 / English : P29 - P55

OM-K0629 002



Thank you for purchasing Air Bearing Turbine Spindle ABT - 1000. This Air Bearing Turbine Spindle is designed for an ultra precision spindle which that is driven by a turbine and supported by an Air Bearing.

The Air Line Kit, Piping Connection Hose, Compressor and Control Unit for Rotation Speed Detection Sensor are required to drive this Air Bearing Turbine Spindle.

Read this and all the associated component Operation Manuals carefully before use.



Always keep this Operation Manual in a place where a user can referred to for reference at any time.

CONTENTS

1. CAUTIONS FOR HANDLING AND OPERATION	P29
2. BASIC PACKAGE	P32
3. WARRANTY	P33
4. CONTACT US	P33
5. FEATURES.....	P34
6. SPECIFICATIONS AND DIMENSIONS	P34
7. INSTALLATION OF THE AIR BEARING TURBINE SPINDLE	P36
8. PIPING, WIRING CONNECTION AND AIR SUPPLY TO THE AIR BEARING	P39
9. CHANGING THE TOOL AND REPLACING THE COLLET	P42
10. START / STOP OPERATION	P45
11. DETECTION OF THE ROTATION SPEED	P48
12. CAUTIONS WHEN USING GRINDSTONES AND TOOLS	P51
13. STORAGE	P53
14. MAINTENANCE AND INSPECTION	P53
15. TROUBLESHOOTING	P54
16. DISPOSAL OF THE AIR BEARING TURBINE SPINDLE	P55

1. CAUTIONS FOR HANDLING AND OPERATION

- Read these warnings and cautions carefully and only use in the manner intended.
- These warnings and cautions are intended to avoid potential hazards that could result in personal injury to the operator or damage to the device. These are classified as follows in accordance with the seriousness of the risk.

Class	Degree of Risk
 WARNING	A safety hazard could result in bodily injury or damage to the device if the safety instructions are not properly followed.
 CAUTION	A hazard that could result in light or moderate bodily injury or damage to the device if the safety instructions are not followed.
INFORMATION	Be sure to keep the usage for your safety.



WARNING

- ① **This Air Bearing Turbine Spindle is not a hand tool. It is designed to be used on CNC machines or special purpose machines.**
- ② **Do not touch the cutting tool while it is running. It is very dangerous.**
- ③ **Wear safety glasses, dust mask and use a protective cover around the Air Bearing Turbine Spindle whenever the Air Bearing Turbine Spindle is rotating.**
- ④ **Never operate or handle the Air Bearing Turbine Spindle until you have thoroughly read the owner's manual and safe operation has been confirmed.**
 - 1) **To prevent injuries / damages, check the Air Bearing Turbine Spindle and cutting tool for proper installation, before operating the Air Bearing Turbine Spindle.**
 - 2) **Before disconnecting the Air Bearing Turbine Spindle, always turn the compressed air supply off. Then it is safe to remove the Air Bearing Turbine Spindle.**
- ⑤ **When installing a tool, tighten the collet correctly and check again the collet and collet nut before use. Do not over-tighten the collet. This may cause damage to the spindle.**
- ⑥ **Do not use bent, broken, chipped, out of round or sub-standard tools, as this may cause them to shatter or explode. Tools with fractures or a bent shank will cause injury to the operator. When using a new tool, rotate it in a low speed and increase speed gradually for safety.**
- ⑦ **Do not exceed the maximum recommended allowable tool speed. For your safety, use speeds below the maximum allowable speed.**
- ⑧ **Do not apply excessive force. This may cause tool slippage, tool damage, injury to the operator or loss of concentricity and precision.**



CAUTION

- ① **Do not drop or hit this Air Bearing Turbine Spindle, as shock can damage to the internal components.**
- ② **Use the our recommended Air Line Kit (AL - A0611 / AL - A1205) or oil mist filterequiped similar product when operating the Air Bearing Turbine Spindle.**
- ③ **Before use, carefully read " Air Line Kit Operation Manual " regarding the correct connection, operation and cautions when using the Air Line Kit.**
- ④ **Be sure to clean the collet and collet nut, the inside of the spindle before replacing the tool. If ground particles or metal chips stick to the inside of spindle or the collet, damage to the collet or spindle can occur due to the loss of precision.**
- ⑤ **When cleaning an Air Bearing Turbine Spindle, stop the Air Bearing Turbine Spindle and remove debris with a soft brush or a cloth. Do not blow air into the Dust Proof Cover Area (refer to section " 6 - 2 Outside View ") with compressed air as foreign particles or cutting debris may get into the Air Bearing.**



CAUTION







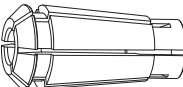
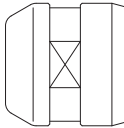

- ⑥ Always clean the tool shank before installing the tool in the spindle.
- ⑦ When sizing the correct collet size to the tool shank diameter, a tolerance of $+0 \sim -0.01\text{mm}$ is strongly recommended.
A tool shank within the $+0 \sim -0.1\text{mm}$ range is mountable, however, this may cause poor concentricity and or insufficient tool shank gripping force.
- ⑧ Be sure to drain moisture and condensation from the Air Line Kit (Oil Mist Filter Bowl) regularly to avoid moisture being carried to the Air Bearing Turbine Spindle. This may cause damage to the Air Bearing Turbine Spindle.
- ⑨ Select suitable products or tools for all applications. Do not exceed the capabilities of the Air Bearing Turbine Spindle or cutting tools.
- ⑩ Do not stop the Air Bearing Turbine Spindle while coolant spray is being applied to the cutting tool. Removing the air pressure from the Air Bearing Turbine Spindle causes a loss of purging, allowing the Air Bearing Turbine Spindle to ingest coolant. This will cause damage to the Air Bearing Turbine Spindle.
- ⑪ Carefully direct coolant spray to the tool. Do not spray directly on the Air Bearing Turbine Spindle body.
- ⑫ Stop working immediately when abnormal rotation or unusual vibration are observed. Immediately, please check the content of section " 15. TROUBLESHOOTING ".
- ⑬ Always check if the tool, collet, collet nut, connection hose and supply air hose are damaged before and after operating.
- ⑭ If the collet or collet nut show signs of wear or damage, replace them before a malfunction or additional damage occurs.
- ⑮ After installation, repair, initial operation, or long periods of non operation, please refer to section " 10 - 1 Break-in Procedure ". When checking the Air Bearing Turbine Spindle, no vibration or unusual sound should be observed during rotation.
- ⑯ Do not attempt to disassemble, modify or attempt to repair this spindle for any reason other than that described in this Operation Manual. Additional damage will occur to the internal components. Service must be performed by NSK NAKANISHI or an authorized service center.
- ⑰ When using this Air Bearing Turbine Spindle for mass production, please consider the purchase of an additional Air Bearing Turbine Spindle to be used as a back-up in case of emergency.
- ⑱ Securely connect the connection hose and supply air hose to the Air Bearing Turbine Spindle and Air Line Kit to avoid accidental disconnection during use.

2. BASIC PACKAGE

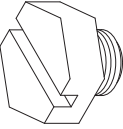
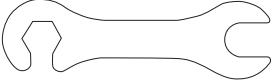
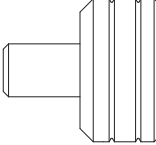
When opening the package, check if it includes all items listed in " Table.1 Packing Contents List ".

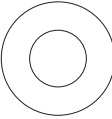
In the event of any shortage, please contact either us (see the " 4. CONTACT US " section) or your dealer.

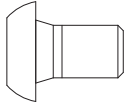
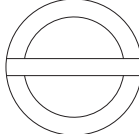
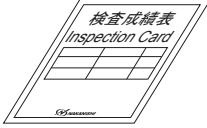
Table. 1 Packing Contents List

<p>ABT-1000 Main body • • 1pc.</p> 	<p>Collet ϕ3.0mm (CHA - 3.0)••1pc.</p> 	<p>Collet Nut (CHN - 3A)••1pc.</p> 
<p>Connection Joint (KQ2S06 - M5N [SMC])••3pcs.</p> 	<p>Connection Joint (M - 5P [SMC])••1pc.</p> 	<p>Wrench (10mm)••1pc.</p> 
<p>Protective Cover••1pc.</p> 	<p>Test Bur (ϕ3mm X 40L)••1pc.</p> 	<p>Bur Wrench (K - 277)••1pc.</p> 
<p>Gasket (for M3 Screw)••1pc.</p> 	<p>Hexagon Wrench (2.0mm)••1pc.</p> 	<p>Hexagon socket button head bolt (M3 X 5L)••1pc.</p> 
<p>Cap (K1020A223)••1pc.</p> 	<p>Inspection Card (KS - 195002)••1pc.</p> 	<p>Operation Manual••1set.</p> 

3. WARRANTY

We provide a limited warranty for our products. We will repair or replace the products if the cause of failure is due to the following manufactures defects. Please contact us or your local distributor for the details.

- ① Defect in manufacturing.
- ② Any shortage in the package.
- ③ Where it is found any damage has occurred when opening the box due to shipping.
(This shall not apply if the damage was caused by the negligence of the end user)

4. CONTACT US

For your safety and convenience when purchasing our products, we welcome your questions. If you have any questions about operation, maintenance and repair of the product, please contact us.

Contact Us

● For U.S. Market

Company Name	: NSK America Corp. Industrial Div.
Business Hours	: 8:00 to 17:00 (CST) (closed Saturday, Sunday and Public Holidays)
U.S. Toll Free No.	: +1 800 585 4675
Telephone No.	: +1 847 843 7664
Fax No.	: +1 847 843 7622
Website	: www.nskamericacorp.com

● For Other Markets

Company Name	: NAKANISHI INC. 
Business Hours	: 8:00 to 17:00 (JST) (closed Saturday, Sunday and Public Holidays)
Telephone No.	: +81 289 64 3520
e-mail	: webmaster-ie@nsk-nakanishi.co.jp

5. FEATURES

- ① Usage of the air bearing / turbine drive is best suited for high speed mold cutting, small diameter drilling, and grinding of highly-detailed parts which require high precision machining.
- ② Optimal cutting conditions when mounted in a CNC Machine are achieved by making use of high speed rotational performance, exceeding 100,000 min⁻¹(rpm). The result will be an increased production performance and superior surface finish.
- ③ Run-out, rotational accuracy and balance are obtained by the adaptation of a high precision collet and collet nut. These high precision characteristics result in prolonged spindle life, tool life and high quality surface finishes.
- ④ The air bearing is a rotating shaft that is floated without contact by supplying dry compressed air from which oil is removed from the bearing gap. This prevents the bearing from being worn and reduced energy consumption to a minimal level. Always use in as clean an environment as possible.
- ⑤ The Air Bearing section should never come in contact with the rotating shaft. In order to suppress any heat generation, due to air resistance during rotation, a highly-functional bearing material has been used in the bearing section to increase the anti-seizing properties and cooling effects.
- ⑥ There are no electronics used to operate this spindle. Operation is performed through the air piping.
- ⑦ This spindle is equipt with a Rotational Speed Detection Sensor IC. When in operation, a signal consistent with rotation speed can be output.
The rotation speed and load condition can be accurately monitored by using a high performance, commercially available meters.

6. SPECIFICATIONS AND DIMENSIONS

6 - 1 Specifications

Model	ABT - 1000
Maximun Rotation Speed	100,000 min ⁻¹ (rpm)
Drive Method	Air Turbine Drive
Bearing Type	Air Static Pressure Bearing
Rotation Direction	Right Hand Rotation (FWD). Viewed from the rear of the Air Bearing Turbine Spindle toward the cutting tool.
Air Bearing Required Air Pressure	0.55MPa
Air Turbine Operating Air Pressure	Less than 0.55MPa
Rotation Speed Detection Method	Magnetic Sensor Method (Output Signal 1pulse / rev)
Spindle Accuracy	Less than 1μm

Weight	820g
--------	------

* For the proper air pressure setting for the Air Turbine, please refer to the Inspection Card.

	Temperature	Humidity	Atmospheric pressure
Operating Environment	0 - 40°C	MAX. 75%	800 - 1,060hPa
Transport and Storage Environment	-10 - 50°C	10 - 85%	500 - 1,060hPa

< Options >

Collet (CHA - □□)	ϕ 0.5mm - 4.0mm in 0.1mm increments are available. ϕ 2.35mm and ϕ 3.175mm
Collet Nut	CHN - 3A

6 - 2 Outside View

When not using the Rotation Speed Detection Sensor IC

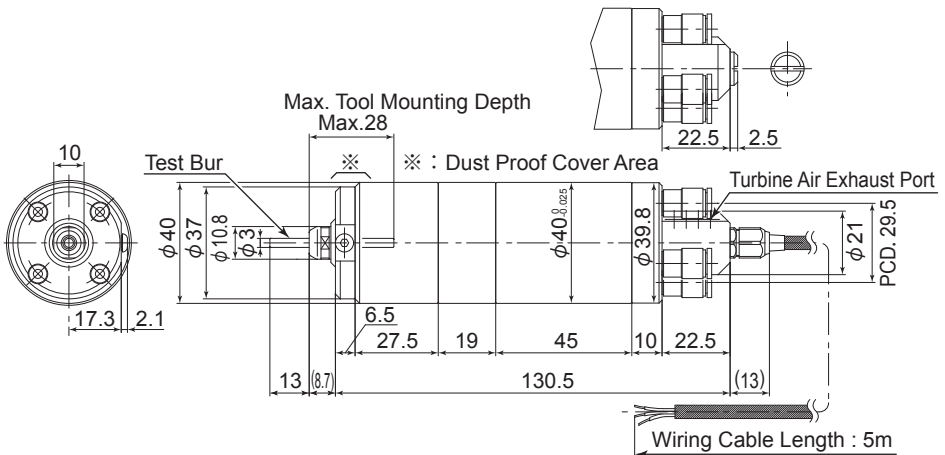

[Magnetic Sensor Wiring Connections]

Wiring Cable (Color) NA20276HB - 26 - 3 (Center Core) [MISUMI]	Rotation Speed Detection Sensor IC
Yellow	VCC (Power Supply Voltage : DC+4V - 24V)
Blue	VOUT (Signal Output)
White	GND (Ground)

Fig. 1

6 - 3 Torque Characteristics

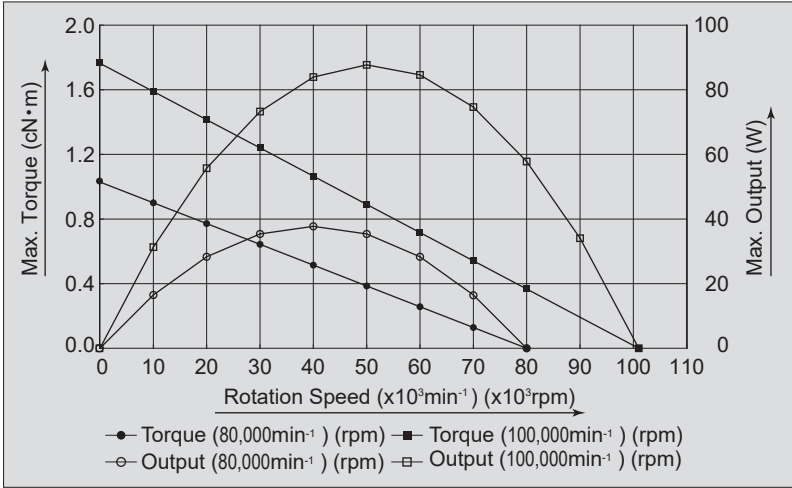

Fig. 2

7. INSTALLATION OF THE AIR BEARING TURBINE SPINDLE

! CAUTION

- When installing an Air Bearing Turbine Spindle, do not hit, drop or cause shock to the Air Bearing Turbine Spindle. This may cause damage to internal components and result in malfunctions.
- When mounting the Air Bearing Turbine Spindle, be sure to secure within Clamping Area (Fig. 3 *) etched on the Spindle O.D. If the Spindle is installed incorrectly, damage to the internal components is possible.
- Cautions When Tightening the Securing Bolts on to a Split Type Holder
Do not over-tighten the bolt. This will cause damage to Air Bearing Turbine Spindle's precision.
Tighten the bolt until the Air Bearing Turbine Spindle body can not be rotated by hand within the fixture.
Extreme tightening is not necessary or recommended.
Apply cutting force to check that the Air Bearing Turbine Spindle is secure before beginning production.
- While the Air Bearing Turbine Spindle is mounted in the machine, always keep air pressure supplied to the air bearing. Contaminants, water and oil may enter into the spindle and cause damage to the air bearing and rotating shaft, resulting in seizing or galling.

- (1) Carefully remove the Protective Cover from the Air Bearing Turbine Spindle.
- (2) When mounting the Air Bearing / Turbine Spindle, pay close to the Clamping Area etched on the O.D. of the Spindle. This Spindle has 3 Clamping Areas. Refer to " 6 - 2 Outside View " (Fig. 1).

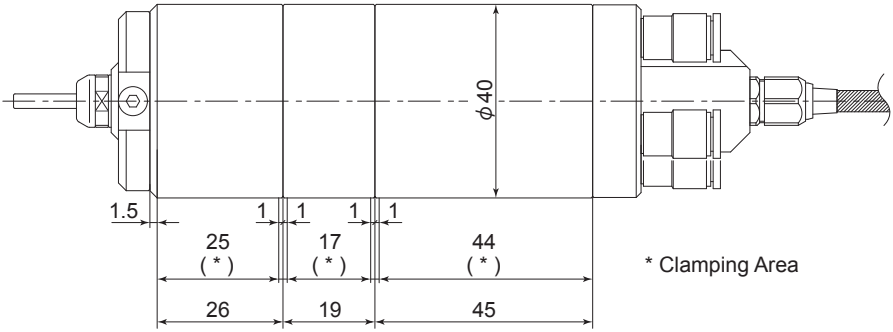

Fig. 3

- * When installing the Air Bearing / Turbine Spindle, it is recommended to use a " GR - 40 Grip Ring (sold separately)" (Fig. 4). If the GR - 40 - Grip Ring is being used, install it as shown in (Fig 3) below.

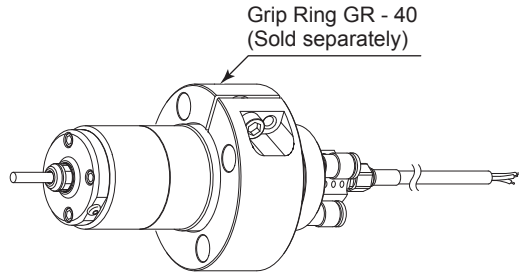

Fig. 4

- (3) When installing an Air Bearing Turbine Spindle to a holder, the recommended installation method is shown Fig. 5. Refer to " (4) How to fabricate a Split Type Holder ".

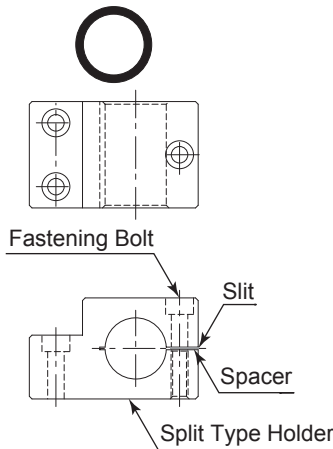

Fig. 5

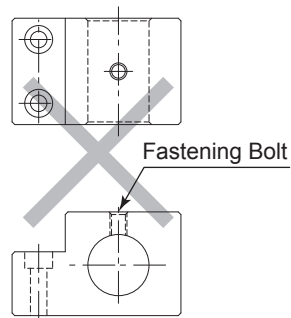

Fig. 6

⚠ CAUTION

Do not allow set screws to come directly in contact with the Air Bearing Turbine Spindle body as shown in Fig. 6, as this will result in damage to the Air Bearing Turbine Spindle housing and internal components. When installing, never clamp directly over the bearings, as this will result in bearing damage. (Refer to Fig. 7)

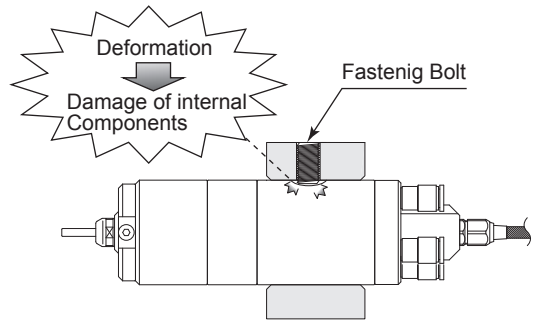

Fig. 7

(4) How to fabricate the Split Type Holder

- ① Rough bore the inside diameter of the Split Type Holder.
- ② Cut a slit. (Ex. Slit 2mm) wide.
- ③ Tighten the Screw for Removal and Force Open the Slit Area.
- ④ Insert a spacer (Ex. thickness = 2mm) into the Slit Area.
- ⑤ Loosen the Screw for Removal, and tighten the fastening bolt with its recommended torque.
- ⑥ Finish the Split Type Holder so that the inside diameter of the Split Type Holder is equal to the Spindle outside diameter. The correct tolerance range for the holder is -0.01mm to -0.015mm and a roundness and cylindricity of less than $5\mu\text{m}$.
- ⑦ When inserting the Air Bearing / Turbine Spindle, loosen the Fastening Bolt, and tighten the Screw for Removal, widening the Slit Area.

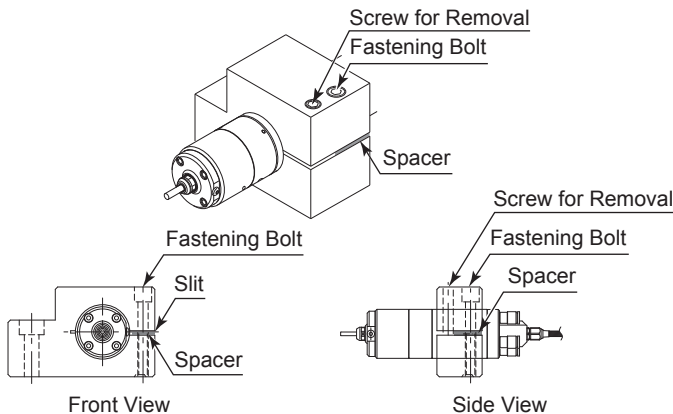

Fig. 8

CAUTION

The final responsibility for ensuring holder's safety for use in a given application is left to the designer of the equipment in which NAKANISHI's Air Bearing Turbine Spindle is installed.

NAKANISHI offers Air Bearing Turbine Spindle with a wide variety of capabilities and specifications.

Please carefully check the Air Bearing Turbine Spindle specifications against the requirements of your equipment and verify suitability and safety of the Holder prior to initial use.

8. PIPING, WIRING CONNECTION AND AIR SUPPLY TO THE AIR BEARING

WARNING

Use the supply air hose (included) and supply pressure no higher than 0.8MPa. If the supplied air is more than 0.8MPa, the supply air hose may rupture and cause injury to the operator.

CAUTION

- Securely connect the air input hose and supply air hose to the Air Bearing Turbine Spindle and Air Line Kit to avoid accidental disconnection and injury to the operator during use.
- Ensure that all parts and tools used for the connection of the Air Line Kit and Air Bearing / Turbine Spindle are clean, as contaminants, water and oil entering the components will cause damage to the system.
- Ensure the air piping connections are correctly connected as instructed in this manual (Refer to Fig. 9).

If connections are incorrectly made, abnormal operation and damage to the Air Bearing Turbine Spindle will occur.

- Be sure to install a proper piping system (refer to Fig.5 and Fig.6) for a clean and dry air supply to the Air Turbine Spindle.

If contaminants, water or oil enter the Air Turbine Bearing Spindle, damage to the Air Bearing Turbine Spindle will occur.

8 - 1 Connection of the Wiring and Piping

- (1) Connection to the Air Bearing Turbine Spindle, consists of air piping and an Rotation Speed Detection Sensor IC Wiring Cable.
Securely connect the air supply piping, referring to " Fig. 9 Marking of the Piping Connection Section " section.
- (2) Rotation Speed Detection Sensor IC wiring (length : 5m) connects to the rear end of the Air Bearing Turbine Spindle. Rotation Speed Detection Sensor IC wiring. Securely connect the Rotation Speed Detection Sensor IC wiring to the Connector (not included / must be prepared by the end-user) .

* The Air Bearing Turbine Spindle and Wiring Cable of the Rotation Speed Detection Sensor IC are not shielded.

It is recommended to shield and earth ground the Air Bearing Turbine Spindles (Rotation Speed Detection Sensor IC Wiring Cable) to reduce the possibility of noise. Depending on each individual installation, cut the wire to the proper length for the final connection (not included / must be prepared by the end-user).

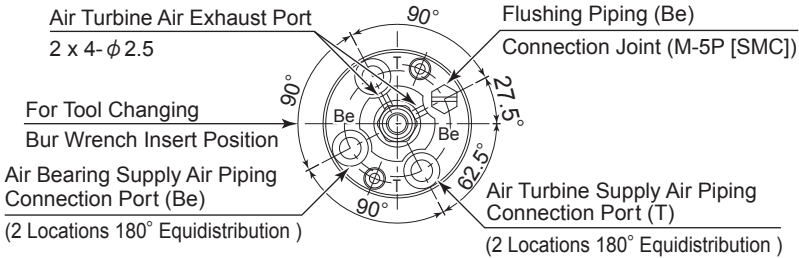

Fig. 9 Marking of the Piping Connection Section

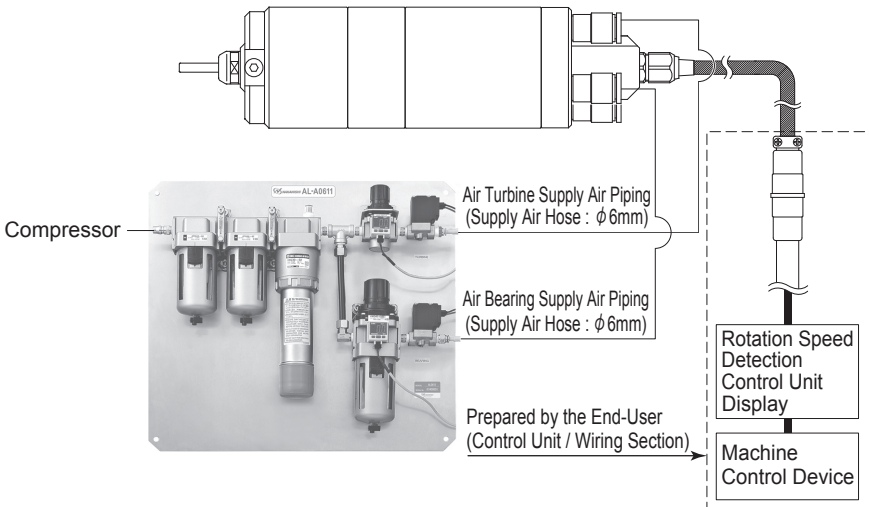
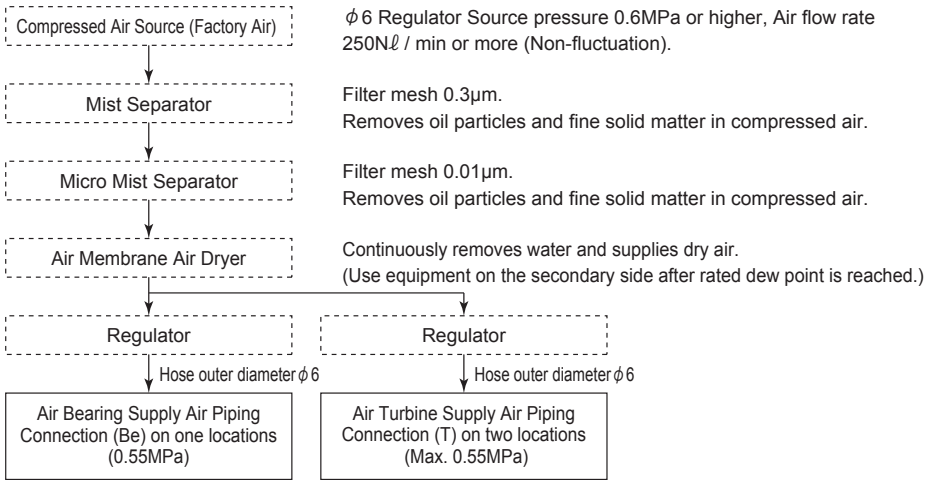

Fig. 10



- * Note 1 : Devices in the broken lined frame are not included with Turbine Spindle, therefore, these items should be prepared by the customer.
- * Note 2 : For details and precautions of each air device, refer to the Operation Manual of the manufacturer from which you purchased the each product.
- * Note 3 : Make sure the set air pressure at the Air Bearing Turbine Spindle piping connection port.

Fig. 11

8 - 2 Procedures to Supply Air to Air Bearing

⚠ WARNING

Do not supply air to the turbine air supply piping before supplying air to the Air Bearing. Failure to do so will cause damage to the rotating shaft.

⚠ CAUTION

- **Be sure to correctly connect the piping and wiring to the Air Bearing Turbine Spindle. If incorrectly wired and plumbed, to the Air Bearing Turbine Spindle, major damage will occur to the air bearing and rotating shaft.**
- **Be sure the set the correct air pressure to the Air Bearing Turbine Spindle connection port. If the piping connection port is separated from the pressure detecting section, the correct air pressure cannot measured.**

- (1) Adjust the set pressure in each piping to 0MPa.
- (2) Perform flushing of air hose to be connected for piping for a few minutes and completely remove contaminants such as water, oil and dust in the piping before use the air hose.
- (3) After the air has been dehumidified to the rated dew point with an air dryer, supply the air to the Air Bearing Supply Air Piping Connection Port (Be).
- (4) Adjust the Air Bearing pressure to 0.55MPa at the piping connection port of the Air Bearing Turbine Spindle.

- (5) Slowly rotate the rotating shaft by hand to check that the shaft rotates smoothly without any abnormal or sticking feeling.
- (6) Leave this Air Bearing Turbine Spindle as it is without operating for approximately 15 minutes after supplying air to the air bearing supply piping. Wait until the inside of the spindle has been sufficiently cleaned and dehumidified.

9. CHANGING THE TOOL AND REPLACING THE COLLET

WARNING

Ensure that the supply air to the turbine spindle has been shut off and the air Turbine has stopped rotating before attempting to change the tool or replace the collet. If accidentally trying to changing the tool or replace the collet while the turbine is rotating, major personel injury will occur.

CAUTION

Keep the air supply to the air bearing ON when changing the tool or replacing the collet.

9 - 1 Changing the Tool

CAUTION

- Do not tighten the collet without inserting a tool or dummy bur, as this will damage the collet, spindle or collet nut, causing difficulty removing the collet.
- When installing a tool, tighten the collet correctly and check again the collet and collet nut before use. Do not over-tighten the collet. This may cause damage to the spindle.
- After changing the tool, measure the run-out accuracy of the outside diameter of the tool shank.
- After replacing a cutting tool, make sure to replace the Hexagon socket head / Button head bolt (Standard accessories : M3 X 5L) into the provided threaded hole of the Dust Proof Cover (Be careful not to overtighten the bolts. This may cause damage to the Air Bearing Turbine Spindle.). Failure to do so will allow contaminants such as water, oil and dust to enter into the Air Bearing Turbine Spindle. This will cause damage to the Air Bearing Turbine Spindle.

RECOMMENDATION

Please set the cutting tools to minimize the overhang amount. 13mm is the maximum amount of overhang to maintain high accuracy and safety.

- (1) Supply proper air pressure to the Air Bearing Turbine Spindle.
- (2) Remove the Hexagon Socket Button Head Bolt (with Gasket (M3 x 5L) (Standard Accessories) on the outside diameter section of Dust Proof Cover by using the Hexagon Wrench (Standard Accessories : 2mm) (Fig. 12).

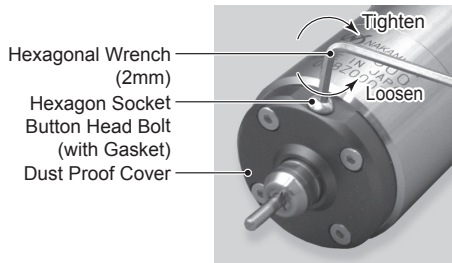
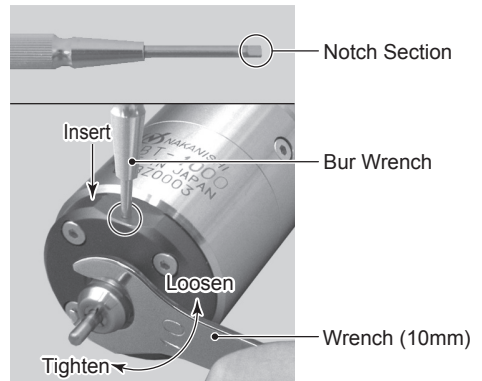

Fig. 12

- (3) Insert the Bur Wrench (Standard Accessories : K - 277) into the Screw Hole located on the O.D. of the Dust Cap. Then insert and fix the end of Bur Wrench (Standard Accessories : K - 277) to the groove on the rotating shaft (Fig. 13).
- (4) Place the wrench (Standard Accessories : 10mm) on the collet nut and turn it counter-clockwise to loosen the collet and remove the tool. (The first turn will loosen the collet nut, but the tool will not release and turning will become stiff. Keep turning through the stiffness and the collet will open.)
- (5) Clean the collet and collet nut, then insert the new tool and tighten the collet by turning clockwise. Do not over-tighten. (Specified Torque : 3 N·m) (Fig. 13).
- (6) Remove the Bur Wrench (Standard Accessories : K - 277) from the Screw Hole.
- (7) Attach the Hexagon Socket Button Head Bolt (with Gasket (M3 X 5L) (Standard Accessories) to the Screw Hole by using the Hexagon Wrench (Standard Accessories : 2mm) (Specified Torque : 30 cN·m).



*Insert the Bur Wrench (2mm) (located at tip notch of the Bur Wrench collet nut side.) to the screw hole, additionally insert the end of Bur Wrench (2mm) to the groove on the rotating shaft.

Fig. 13

9 - 2 Replacing the Collet

CAUTION

When installing the collet into the collet nut, be sure to fully engage the latch inside the collet nut to the groove on the collets outer diameter area.

Precautions: If the collet is attached without being engaged to the latch of the collet nut:

- The collet will remain attached to the spindle shaft or cannot be removed.
- The tool cannot be properly gripped, resulting in a dangerous situation or injury due to the tool coming out of the spindle.
- The collet, collet nut or spindle shaft have be damaged and may cause the collet to be stuck in the Air Bearing Turbine Spindle.

- (1) Supply proper air pressure to the Air Bearing Turbine Spindle.
- (2) Remove the tool according to the section " 9 - 1. Changing the Tool " procedure above and remove collet nut assembly. (Fig. 14)
- (3) The collet and collet nut are secured by a groove in the collet and a flange in the collet nut. To remove the collet hold the collet nut in one hand and push diagonally down on the collet. The collet should be released (Fig. 15).
- (4) To install the collet, hold the collet at a slight angle, and insert it into the collet nut (Fig. 16).

Press the collet in the collet nut by positioning the collet in the collet nut and pressing down on flat surface (Fig. 15).

Be sure to fully engage the latch inside the collet nut into the groove on the collets outer circumference area (Fig. 17).

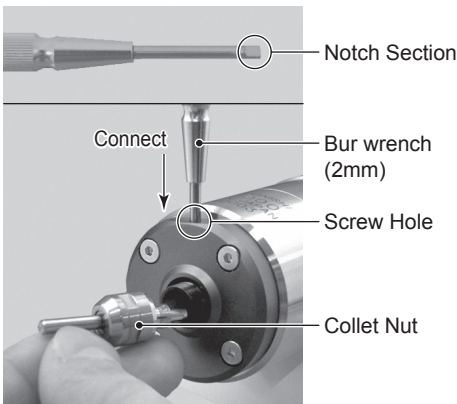

*Insert the Bur Wrench (2mm) (located at tip notch of the Bur Wrench collet nut side.) to the Screw Hole, additionally insert the end of Bur Wrench (2mm) to the groove on the rotating shaft.

Fig. 14

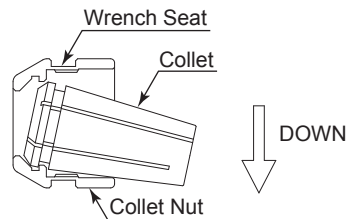

Fig. 15

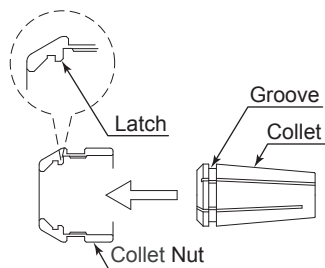

Fig. 16

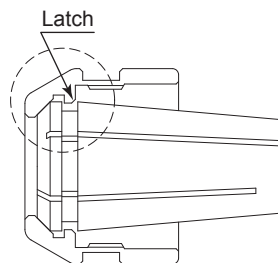

Fig. 17

10. START / STOP OPERATION

⚠ WARNING

- Make sure the completely removed the tool (spanner or wrench) from the Air Bearing Turbine Spindle. Always keep in mind that the tool will fly off, and this may cause injury and damage to property or operator if the shaft is rotated with the tools engaged.
- Wear safety glasses, dust mask, and use a protective cover around the Air Bearing Turbine Spindle whenever the Air Bearing Turbine Spindle is rotating.
- Do not exceed maximum rotation speed operation. This may cause damage to the Air Bearing Turbine Spindle.
- Make sure to correctly set air pressure to the Air Bearing Turbine Spindle piping connection ports. If the piping connection port is separated from the pressure detecting section, proper air pressure cannot be measured.
- Remember that rotation is not completely stopped when air flow to the air bearing is removed, even though air pressure to the turbine has been turned off. Do not touch the cutting tool until visual inspection shows the cutting tool has stopped rotating.

⚠ CAUTION

- Re-check for proper supply air pressure to the air bearing, piping connection and correct mounting.
- Remember that there is no air purge when air is not supplied to the air bearing and turbine. Contaminants, water and oil may enter into the spindle and cause air bearing and rotating shaft, causing seizing or galling. When the air supply to the air bearing or air turbine is not present, please observe the following precautions (1) to (3).
 - (1) Never rotate the spindle shaft unnecessarily.
 - (2) Do not spray coolant directly on the Air Bearing Turbine Spindle body.
 - (3) Do not blow air directly to the Air Bearing Turbine Spindle body.



CAUTION

- If the Air Bearing Turbine Spindle is going to remain in the machine, even though it is not being used, always supply air pressure to the air bearing. Contaminants, water and oil may enter into the spindle, causing the air bearing or rotating shaft to seize or become galled.
- Immediately stop operation and shut off the supply air if abnormal rotation or unusual vibration are observed. Please check the content of P54 " 15. TROUBLESHOOTING " section.
- If the air pressure to the air bearing is low or air pressure to the air bearing is incorrectly shut off during operation by mistake, the air bearing will operate abnormally, causing the rotating shaft and the bearing come into contact with each other causing severe damage. Always observe the correct pressure.

INFORMATION

Adjust the rotating speed by adjusting the regulator to the correct values as described in the inspection table.

Caution must always be observed when rotating the Air Bearing Turbine Spindle at high speeds to avoid any dangerous situations. Carefully read Section " 10 - 1 Break-in Procedure " and " 10 - 2 Running / Stop procedures ", to ensure safe operating conditions. Always be prepared to stop the Air Bearing Turbine Spindle if abnormal conditions are observed. For original factory specifications, refer to " Inspection Card (KS - 195002) " included with the unit. After initial installation, repair, or extended periods of non operation, please follow the " 10 - 1 Break-in Procedure ".

10 - 1 Break-in Procedure



CAUTION

Check set air pressure (0.55MPa (79.8psi)) is always supplied into the Air Bearing before operation.

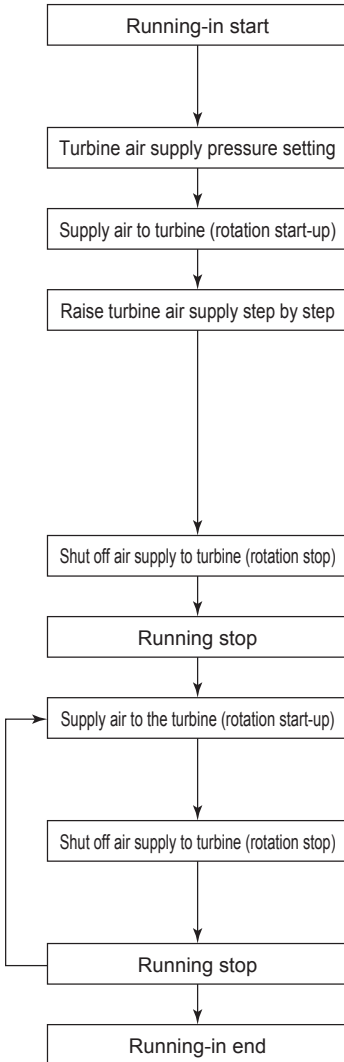

Check the set air pressure of the Air Bearing (0.55MPa). Supply to the Air Bearing. Mount tool correctly. Check the wiring of the Rotation Detection Sensor IC.

Set the turbine air supply pressure to 0 MPa by the regulator in advance.

Apply air supply pressure to the turbine.

Raise the air supply pressure in the following order. (Stand by for 3 minutes after rotation stop at each pressure, and stand by for 10 minutes at maximum rotation pressure [0.55MPa])

0.1MPa→0.2MPa→0.3MPa→0.4MPa

→0.5MPa→0.55MPa (Stand by for 10 minutes).

※1 Check the proper rotation speed by Rotation Detection Sensor IC during operation of the Air Bearing Turbine Spindle.

Shut off air supply to the turbine. (Stop time about 100 seconds.)

Start up immediately to the maximum rotation and stand by for 3 to 5 minutes. (Accelerating time about 25 seconds.)

Repeat start-up and stop a few times to check that rotation is normally performed. Stop rotation.

Fig. 18

10 - 2 Running / Stop Procedures

⚠ CAUTION

Check set air pressure (0.55MPa (79.8psi)) is always supplied into the Air Bearing before operation.

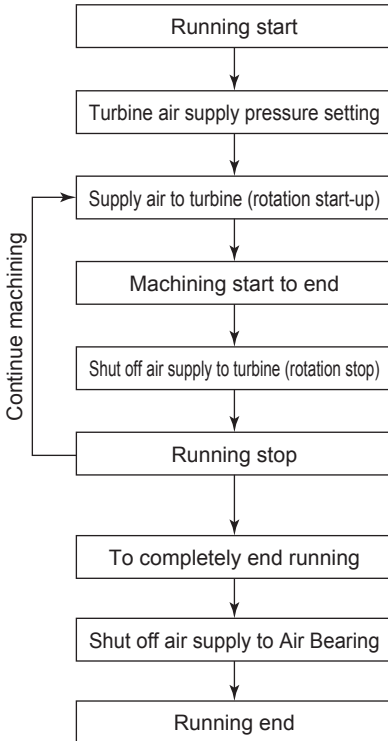

Check the set pressure for the air bearing (0.55MPa) and supply air if it is insufficient. Mount tool correctly.

Set the rotation speed necessary for running or machining in advance. Set it not to exceed maximum rotation speed.

Apply air supply pressure to the turbine. Stand by until a set rotation is reached from rotation start-up.

Shut off air supply to the turbine. (allowed to stop suddenly)

Stop rotation and replace the tool if necessary. (Normally, keep supplying air to the air bearing after the operation has ended.) Keep the right state of the air bearing.

Reconfirm the rotating stop state.

Completely stop rotation. Then shut off air supply to the Air Bearing.

Fig. 19

11. DETECTION OF THE ROTATION SPEED

11 - 1 Wiring of the Rotation Speed Detection Sensor IC

⚠ CAUTION

- Do not apply excess voltage or current to the Rotation Speed Detection Sensor IC.
- Incorrect wiring will cause damage to the Air Bearing Turbine Spindle.
- Connect the proper wiring leads to the Rotation Speed Detection Sensor IC.
- To minimize RF interference and noise, please minimize the length of the Wiring Cables to the Rotation Speed Detection Sensor IC.
- Do not disassemble any component that is not authorized in this Operation Manual.

[Checking and Adjusting the Rotation Speed of the Air Bearing Turbine Spindle]

Rotational speed from zero to its maximum speed using a digital pulse signal from the Rotation Speed Detection Sensor IC is performed by connecting using a commercial tachometer or speed measuring device to the Rotation Speed Detection Sensor IC built into the Air Bearing Turbine Spindle. The Rotation Speed Detection Sensor IC is designed to accurately detect a target located on the face of the Rotation Shaft. The rotational speed is adjusted by regulating the air pressure supplied from the Air Line Kit to the Turbine and Air Bearing.

Maximum speed of rotation : $100,000\text{min}^{-1}$ (rpm) (rotation frequency : approx. $1,667\text{Hz}$)
 : Output of 1 pulse / rev signal

Circuit Diagram of Rotation Speed Detection Sensor IC, refer to Fig. 20.

[Control Output Circuit]

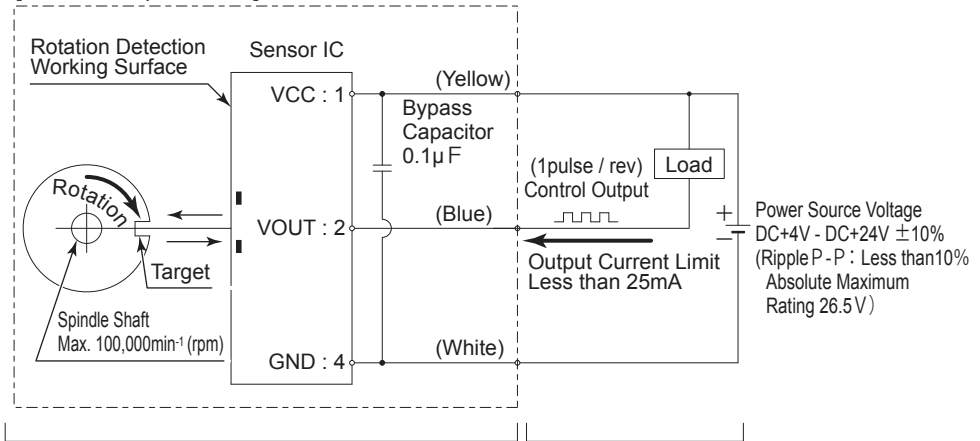

Internal Circuit of the Air Bearing Turbine Spindle

Connection Example : Tachometer / Measuring Device
 (Not included / provided by the end-user.)

Fig. 20

11 - 2 When not using the Rotation Speed Detection Sensor IC.

The Rotation Speed Detection Sensor IC and Wiring Cable can be removed from the Air Bearing Turbine Spindle. To remove the Rotation Speed Detection Sensor IC and Wiring Cable, refer to "[Removing the Rotation Speed Detection Sensor IC]".

CAUTION

- Remove all Piping Connections from the Air Bearing Turbine Spindle before removing the wiring of Rotation Speed Detection Sensor IC (Do not disassemble anything that is not authorized in this Operation Manual).
- Your hands and all associated tools, as well as Air Bearing Turbine Spindle, Piping connections and tubing must be clean before servicing this unit. Contaminants, water and oil may enter into the Air Bearing Turbine Spindle, causing seizing and galling to the air bearing and rotating shaft.

⚠ CAUTION

- Carefully connect the Piping to the proper positions of the Air Bearing Turbine Spindle (Fig. 9).
- Check for proper seating of the O-Rings (4 pcs.) in the O-Ring grooves in the Piping Flange before mounting the Piping Flange to the Air Bearing Turbine Spindle body.
- If the O-Rings (4pcs.) are difficult to install, apply small amount of grease to the O-Rings before mounting the Piping Flange to the Air Bearing Turbine Spindle. After mounting, wipe away the excess using alcohol and a soft cloth.

[Removing the Rotational Speed Detection Sensor IC]

- (1) Place the Wrench (10mm provided wrench) on the Cable Clamp and turn it counter-clockwise to remove the Cable Clamp (Fig. 21).
- (2) Loosen the Mounting Screw (2 - M3) on the Piping Flange by using a 2.5mm Hexagon Wrench (not included / prepared by the end-user) (Fig. 21).
- (3) Remove the Piping Flange from the Air Bearing Turbine Spindle body.
- (4) Remove the Sensor Set Screws (2pcs. M2.6) inside the Piping Flange by using the 2.0mm Hexagon Wrench (provided).
- (5) Carefully pull out the Cable Clamp and Wiring Cable from the Piping Flange.
- (6) Install the Cap (Standard Accessory : K1020A223) to the Piping Flange by using a Flat-Blade Screwdriver (not included / provided by the end-user) (Fig. 23).
- (7) Install the Piping Flange to the rear end of Air Bearing Turbine Spindle with the 2pcs. / 3mm set Screws (provided) and securing with the 2.5mm Hexagon Wrench (Provided) (Fig. 23).
- (8) Supply the proper air pressure to the Air Bearing Supply Air Piping Connection Port (Be). Ensure there is no air leakage and proper flotation of the rotating shaft.
- (9) If the installation is successful, please perform the break-in procedure detailed in " 10 - 1 Berak-in Procedure " section. If installation is abnormal, re-check the mounting of Piping Flange.

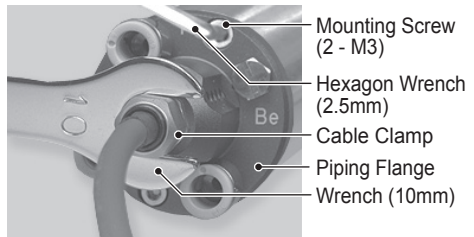

Fig. 21

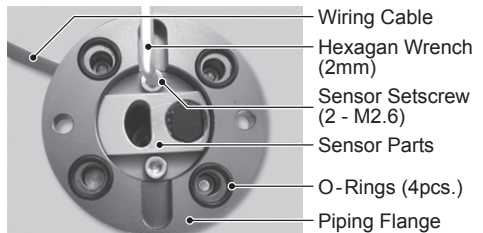

Fig. 22

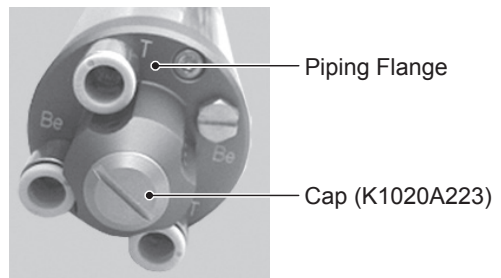

Fig. 23

12. CAUTIONS WHEN USING GRINDSTONES AND TOOLS

CAUTION

The maximum surface speed or rpm is always specified for a grindstone. Do not exceed the maximum speed with reference to the calculating chart below. Always follow the grindstone manufacturer's recommendations.

$$\text{Surface Speed (m / s)} = \frac{3.14 \times \text{Diameter (mm)} \times \text{Rotation Speed (min}^{-1}\text{) (rpm)}{1,000 \times 60}$$

- (1) The proper surface speed for general grindstones is 10 - 30m / s.
- (2) Do not exceed 13mm of overhang for mounted grindstones as shown in Fig. 24.
If the overhang must exceed 13mm, reduce the rotation speed in accordance with Table 2 and Table 3.
- (3) Dress the grindstone prior to use.
- (4) Do not use cutting tools with bent or broken shanks, cracks or excessive run-out.
- (5) For grinding, the maximum depth of cut should not exceed 0.01mm radially or axially.
Reciprocate the tool several times after each pass to eliminate tool pressure.
- (6) Always operate cutting tools within the allowable recommended speed of the cutting tools. Use of a cutting tool outside of the allowable speed of the cutting tools could cause damage to the spindle and injury to the operator.
- (7) Keep the cutting tool shank and collet clean. If contaminants are left in the collet or collet nut, excessive run-out will cause damage to the cutting tool and or spindle.
- (8) Do not strike or disassemble the Air Bearing Turbine Spindle.
- (9) Please minimize the tool overhang amount to maintaining high accuracy. 13mm is the maximum amount of overhang to maintain high accuracy and safety.
- (10) Do not apply excessive force as to cause more than a 10% decrease of the rotation speed.

RECOMMENDATION

It is recommend to perform a complete operational, rotation and shutdown procedure test to ensure there is no excessive force on the Rotation Speed Detection Sensor IC.

Table 2.

Use this Maximum Rotation Speed Table when exceeding the " Range of Tool Overhang " recommendations (Refer to Fig. 24).

Tool Sizes	Maximum Rotation Speed (min^{-1}) (rpm)
ϕ 4 X 17L	Less than N X 1.0
ϕ 4 X 25L	Less than N X 0.9

Table 3.

For maximum rotation speed, set air pressure to 0.5MPa.

Tool Sizes	Maximum Rotation Speed (min^{-1}) (rpm)
ϕ 4 X 17L	Less than N X 1.0
ϕ 4 X 25L	Less than N X 0.85

"N" is the maximum rotation speed used in the formula for "Range of Tool Overhang " (Refer to Fig. 24) ($100,000\text{min}^{-1}$) (rpm)).

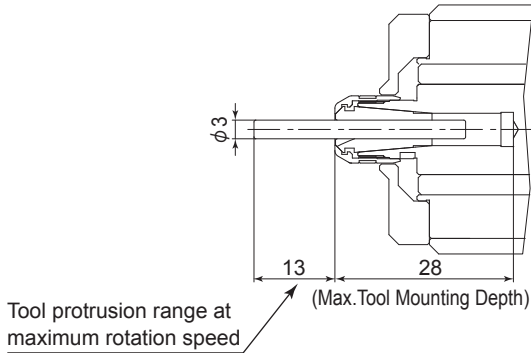

Fig. 24

13. STORAGE

CAUTION

- Clean so as to prevent contaminants or foreign matter from entering into the piping, air lines or inside of the Air Bearing / Turbine Spindle.
- Do not apply rust inhibitor or rust preventive to the Air Bearing Turbine Spindle. Should any of these chemicals enter into the spindle bearing section or inside of the piping, loss of precision and damage to the Air Bearing Turbine Spindle will result.
- When attaching the test bur for storage of the spindle, attach the Protective Cover provided over the test bur to eliminate the chance of damaging the test bur.
- Wrap the spindle with the vapor phase corrosion inhibitor wrapping film in which the spindle was originally packaged with at the factory. Wrap the spindle in the quilting material and store in the original factory corrugated box.
- Follow to the " STORAGE, INSTALLATION and OPERATION " (Refer to " 6 - 1. Specifications ") recommendations.

14. MAINTENANCE AND INSPECTION

14 - 1 Routine Pre-operation Checks

- (1) Cleanliness of supplied air.
- (2) Check the air supply pressure to the Air Bearing and Air Turbine.
- (3) Check for damage to the Piping Joint and wiring of the Rotation Speed Detection Sensor IC and supply air hose.
- (4) Check for abnormal vibration, abnormal sound or heat generation during test or operation.

14 - 2 Cleaning

CAUTION

Do not spray coolant and compressed air into the Air Bearing Turbine Spindle. This will cause contaminants, oil and water to enter Air Bearing Turbine Spindle. Damage to the Air Bearing and Turbine Shaft will occur.

- (1) Shut off the supply pressure to the Air Turbine first before shutting off the air to the Air Bearing.
- (2) Always keep air supplied to the Air Bearing. Wipe any debris off of the Air Bearing Turbine Spindle.

14 - 3 Flushing

CAUTION

- Do not flush lines for purposes other than maintenance or when problems such as a failure has occurred.
- When flushing the Air Bearing Turbine, use very clean and dry air.

- (1) Remove the Flushing Piping (Be) Connection Joint (M - 5P [SMC]) (Fig. 25 ①) from the Air Bearing Turbine Spindle.
- (2) Supply air to the Air Bearing Supply Air Piping Connection Port (Be) (Fig. 25 ②) of 180 degree other side.
- (3) Attach the cleaned and air blew Flushing Piping (Be) Connection Joint (M - 5P [SMC]) (Fig. 25 ①) to the Air Bearing Turbine Spindle.
- (4) Supply air to the air bearing.
- (5) Check the non-air leak from the " Flushing Piping (Be) Connection Joint (M - 5P [SMC]) (Fig. 25 ①) " connection section of rear end of the Air Bearing Turbine Spindle.

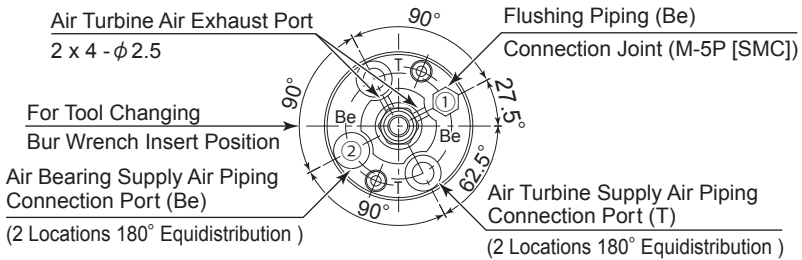

Fig. 25 Marking of the Piping Connection Section

15. TROUBLESHOOTING

If a problem or concern occur, please check the following items prior to consulting your dealer.

Trouble	Cause	Inspection / Corrective Action
Air Turbine Bearing Spindle does not rotate or increase rotation speed.	Low Air Pressure.	Check the Compressor, Air Circuit, and Regulator.
	Diameter of a hose used for air supply piping is too small.	Replace with the proper diameter hose.
	Contaminants, oil or water have entered into the air supply piping (to the Air Bearing or to Air Turbine inlets).	Repair is necessary . (Return to NAKANISHI dealer service.)

Trouble	Cause	Inspection / Corrective Action
Air Turbine Bearing Spindle does not rotate or increase rotation speed.	When rotating the spindle shaft by hand, there is some abnormal or sticky feeling.	Return to NAKANISHI dealer service.
	Excess load or contact to the bearing have resulted in a constant reduction in the rotation speed or complete stopping of the spindle shaft.	Reduce the excessive load. If the spindle shaft is sticking or seized return to NAKANISHI dealer service immediately.
	There is continuity with air supplied.	Spindle shaft has been damaged. (Return to NAKANISHI dealer service.)
Abnormal vibration or noise during rotation.	Proper air pressure is not supplied to the Air Bearing.	Set the supply air pressure to the recommended air pressure.
	The tool is bent.	Change the tool.
	Tool Mounting extension has been exceeded (refer to " Range of Tool Overhang ".)	Be sure to mount the tool within the " Range of Tool Overhang " chart.
Rotational Speed cannot be detected.	Incorrect connection of the Rotation Speed Detection Sensor IC Wiring Cable.	Check the wiring lead positions and wiring connections of the Rotation Speed Detection Sensor IC Wiring Cable.
	Sensor Cable Wiring Connector has been damaged.	Repair is necessary . (Return to NAKANISHI dealer service.)
High run-out.	The tool is bent.	Change the tool.
	Collet nut is not correctly installed.	Secure the collet and the collet nut correctly.
	The collet and the collet nut are worn.	Replace the collet and the collet nut.
	Contaminants inside the collet and the collet nut or the spindle.	Clean the collet, collet nut and the inside of the taper and spindle.
	Proper air pressure is not supplied to the Air Bearing.	Set the supply air pressure to the proper air pressure.

16. DISPOSAL OF THE AIR BEARING TURBINE SPINDLE —

When disposal of an Air Bearing Turbine Spindle is necessary, follow the instructions from your local government agency for proper disposal of industrial components.

株式会社ナカニシ www.nakanishi-inc.com

〒322-8666 栃木県鹿沼市下日向700
TEL: 0289-64-3380 FAX: 0289-62-5636

NAKANISHI INC.  www.nakanishi-inc.com

700 Shimohinata, Kanuma, Tochigi 322-8666, Japan

NSK America Corp. www.nskamericacorp.com

1800 Global Parkway, Hoffman Estates, IL 60192, USA

NSK Europe GmbH 

Elly-Beinhorn-Strasse 8, 65760 Eschborn, Germany

NSK United Kingdom Ltd. UK Responsible Person

Office 4, Gateway 1000, Arlington Business Park, Whittle Way, Stevenage, SG1 2FP, UK

本書の内容は、改善のため予告なしに変更することがあります。

Contents are subject to change without notice.