

# Motor Spindle

## BMS-4040-RGD-03M • BMS-4040-RGD-2M BMS-4040RA-RGD-03M • BMS-4040RA-RGD-2M



# OPERATION MANUAL

OM-K0697E 001

Thank you for purchasing motor spindle BMS-4040-RGD-03M • BMS-4040-RGD-2M • BMS-4040RA-RGD-03M • BMS-4040RA-RGD-2M. This motor spindle is designed for high precision machining including grinding, drilling and milling. The <E4000 CONTROLLER> and the <Air Line Kit> are required to drive this motor spindle. Read this Operation Manual carefully before use. Also read <E4000 CONTROLLER> and the <Air Line Kit> Operation Manual.

### 1. CAUTIONS FOR HANDLING AND OPERATION

- Read these warnings and cautions carefully and only use in the manner intended.
- These warnings and cautions are intended to avoid potential hazards that could result in personal injury or damage to the device. These are classified as follows in accordance with the seriousness of the risk.

Class	Degree of Risk
 <b>WARNING</b>	A safety hazard could result in bodily injury or damage to the device if the safety instructions are not properly followed.
 <b>CAUTION</b>	A hazard that could result in light or moderate bodily injury or damage to the device if the safety instructions are not followed.

#### **WARNING**

- ① This motor spindle is not a hand tool. It is designed to be used on CNC machines or special purpose machines.
- ② Do not touch the cutting tool while it is running. It is very dangerous.
- ③ Wear safety glasses, dust mask and hearing protection, and use a protective cover around the motor spindle whenever the motor spindle is rotating.
- ④ Never connect, disconnect or touch the Power Cord Plug and Motor Cord Connector with wet hands. This may cause an electric shock.
- ⑤ Never operate or handle the motor spindle until you have thoroughly read the owner's manual and safe operation has been confirmed.
  - 1) To prevent injuries/damages, check this motor spindle and cutting tool for proper installation, then operate this motor spindle.
  - 2) Before disconnecting this motor spindle, always turn the control power off and turn the compressed air supply to the control unit off. It is then safe to remove this motor spindle.
- ⑥ When installing a tool, tighten the collet correctly and check again the collet and collet nut before use. Do not over-tighten the collet. This may cause damage to the motor spindle.
- ⑦ Do not use bent, broken, chipped, out of round or sub-standard tools as they can shatter or explode. It shatters, it cracked, and the tool that bends and breaks disperses and it causing injures. When using a new tool, rotate it in a low speed and increase speed gradually for safety.
- ⑧ Do not exceed the maximum recommended allowable tool speed. For your safety, use speeds below the maximum allowable speed.
- ⑨ Do not apply excessive force. This may cause tool slippage, tool damage, injury to the operator, loss of concentricity and precision.

## ⚠ CAUTION



- ① Do not drop or hit this motor spindle, as shock can damage to the internal components.
- ② Be sure to clean the collet and collet nut, the inside of the spindle before replacing the tool. If ground particles or metal chips stick to the inside of spindle or the collet, damage to the collet or spindle can occur due to the loss of precision.
- ③ When cleaning a spindle, stop the motor and remove dirt with a brush or a cloth. Do not blow air to a dust proof area (refer to Section 6 - 2 "Outside view" ) with compressed air, foreign particles or cutting chips might get into the ball bearing.
- ④ Always clean the tool shank before installing the tool in the motor spindle.
- ⑤ Use only tools with shank diameters within the tolerance of the selected collet.
- ⑥ Select suitable products or tools for all applications. Do not exceed the capabilities of the motor spindle or tools.
- ⑦ Carefully direct coolant spray to the tool. Do not spray directly on the motor spindle body.
- ⑧ Stop working immediately when abnormal rotation or unusual vibration are observed. Afterwards, please check the content of Section " 13. TROUBLESHOOTING".
- ⑨ Always check if the tool, collet or collet nut are damaged before and after operating.
- ⑩ If the collet or collet nut show signs of wear or damage, replace them before a malfunction or additional damage occurs.
- ⑪ After installation, repair, initial operation, or long periods of non operation, please refer to Section " 11. BREAK-IN PROCEDURE" detailed in Table 1. When checking the motor spindle, no vibration or unusual sound should be observed during rotation.
- ⑫ Do not disassemble, modify or attempt to repair this motor spindle. Additional damage will occur to the internal components. Service must be performed by NSK NAKANISHI or an authorized service center.
- ⑬ When using this motor spindle for mass production, please purchase the another motor spindle as a spare in case of an emergency.

## 2. BASIC PACKAGE

When opening the package, check if it includes all items listed in " Table. 1 Packing List Contents ".

In the event of any shortage, please contact either NAKANISHI (see the " 4. CONTACT US " section) or your local dealer.

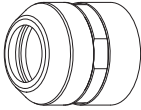
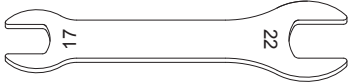
Table. 1 Packing List Contents

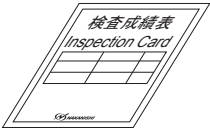
<p>Motor Spindle • • 1pc.</p> 	<p>Collet Nut (CHN-16) • • 1pc.*</p> 	<p>Wrench (17 × 22) • • 2pcs.</p> 
<p>Operation Manual • • 1set.</p> 	<p>Inspection Card • • 1pc.</p> 	

\* The Collet Nut is attached to the air bearing spindle.

## 3. WARRANTY

We provide a limited warranty for our products. We will repair or replace the products if the cause of failure is due to the following manufactures defects. Please contact us or your local distributor for details.

- (1) Defect in manufacturing.
- (2) Any shortage of components in the package.
- (3) Where damaged components are found when initially opening the package.  
(This shall not apply if the damage was caused by the negligence of a customer.)

## 4. CONTACT US

For your safety and convenience when purchasing our products, we welcome your questions. If you have any questions about operation, maintenance and repair of the product, please contact us.

### Contact Us

#### ● For U.S. Market

Company Name	: <b>NSK America Corp.</b> Industrial Div.
Business Hours	: 8:00 to 17:00 (CST) (closed Saturday, Sunday and Public Holidays)
U.S. Toll Free No.	: +1 800 585 4675
Telephone No.	: +1 847 843 7664
Fax No.	: +1 847 843 7622
Website	: <a href="http://www.nskamericacorp.com">www.nskamericacorp.com</a>

#### ● For Other Markets

Company Name	: <b>NAKANISHI INC.</b> 
Business Hours	: 8:00 to 17:00 (JST) (closed Saturday, Sunday and Public Holidays)
Telephone No.	: +81 289 64 3520
e-mail	: <a href="mailto:webmaster-ie@nsk-nakanishi.co.jp">webmaster-ie@nsk-nakanishi.co.jp</a>

## 5. FEATURES

- ① The motor spindle housing is made from precision ground, hardened, stainless steel (SUS) with an outside diameter of  $\phi 40$ mm.
- ② Excellent durability and high reliability are obtained by using a high-speed brushless motor, which eliminates the need for brush replacement and frequent maintenance.
- ③ A quick disconnect cord is available for easy motor removal.

## 6. SPECIFICATIONS AND DIMENSIONS

### 6 - 1 Specification

Model	BMS-4040-RGD-03M	BMS-4040-RGD-2M	BMS-4040RA-RGD-03M	BMS-4040RA-RGD-2M
Maximum Motor Rotation Speed	40,000 min <sup>-1</sup>			
Spindle Accuracy	Within 1 $\mu$ m			
Max. Output	1,200W			
Noise Level	Less than 70dB(A)			
IP Code	Motor Spindle : IP57, Motor Cord : IPX7			
Weight	1.4kg	1.9kg	1.4kg	1.9kg

<Option>

Collet (CH16- <input type="checkbox"/> <input type="checkbox"/> )	$\phi$ 3.0mm、 $\phi$ 3.175mm、 $\phi$ 4.0mm、 $\phi$ 6.0mm、 $\phi$ 6.35mm、 $\phi$ 8.0mm、 $\phi$ 10.0mm
Collet Nut	CHN - 16

*Note1	EMCD - 4000 - <input type="checkbox"/> M (Power Line)	Motor Cord Length : 2m, 4m, 6m and 8m. (The Air Hose ( $\phi$ 6mm) of the same length is attached.)
	EMCD - 4000S - <input type="checkbox"/> M (Signal Line)	Motor Cord Length : 2m, 4m, 6m and 8m.

\*Note 1 : Motor Cord is sold separately. Please select the suitable motor coed length for your application.

**CAUTION**

These Motor Cord <EMCD - 4000 - 8M and EMCD - 4000S - 8M> are never use for Angle Type Motor Spindle <BMS-4040-RGD-2M / BMS-4040RA-RGD-2M>.

**6 - 2 Outside View**

① BMS-4040-RGD-03M • BMS-4040-RGD-2M

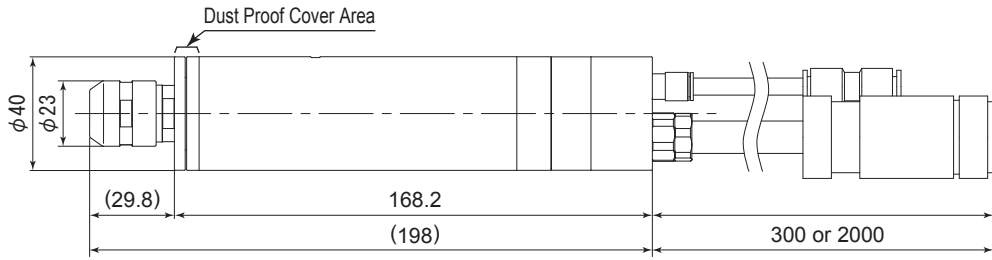

Fig. 1

② BMS-4040RA-RGD-03M • BMS-4040RA-RGD-2M

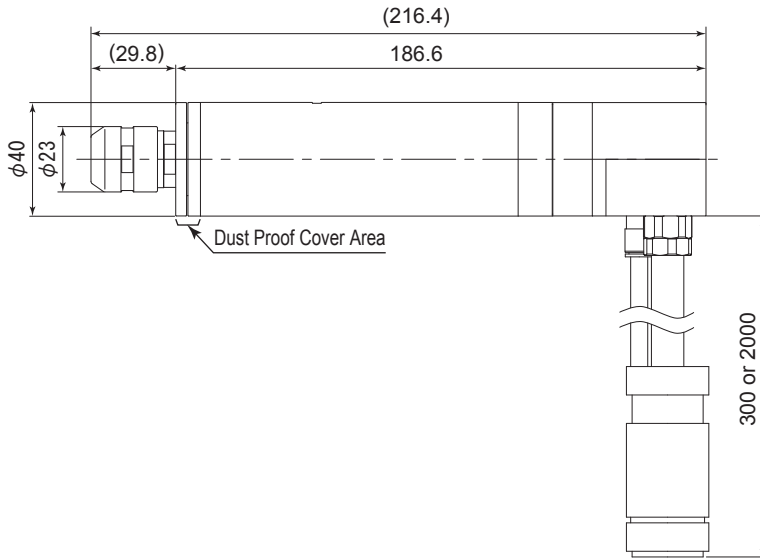

Fig. 2

**6 - 3 Torque Characteristics**

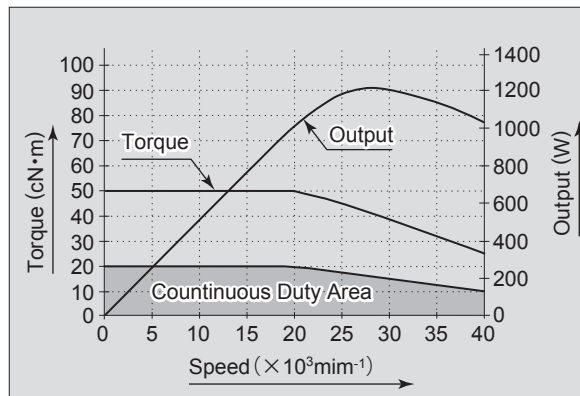

Fig. 3

## 6 - 4 Air Supply

Please set the air pressure to 0.35MPa for continuous use, although the motor spindle can be operated at the air pressure within 0.2MPa~0.35MPa.

## 7. CHANGING THE CUTTING TOOL

### ⚠ CAUTION

**Do not tighten the collet without inserting a cutting tool or dummy bur, as this will damage the collet, spindle or collet nut, causing difficulty remove the collet.**

- ① Set the provided 17mm wrench on the spindle.
- ② Place the provided 22mm wrench on the collet nut and turn it counterclockwise to loosen the collet and remove the cutting tool. (The first turn will loosen the collet nut, but the tool will not release and turning will become stiff. Keep turning through the stiffness and the collet will open.)
- ③ Insert the new tool and tighten the collet by turning clockwise.

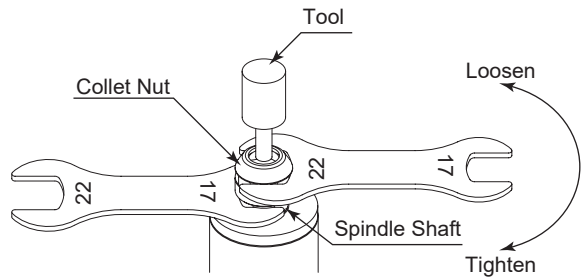

Fig. 4

## 8. REPLACING THE COLLET

### ⚠ CAUTION

**When installing the collet in the collet nut, make sure to fully engage the latch inside the collet nut to the groove on the collet outer circumference area. In addition, remember that if the collet is attached without being engaged with the latch of the collet nut, the collet cannot be removed and this may cause damage to the collet or the spindle.**

- ① Remove the tool according to the section "7. CHANGING THE CUTTING TOOL" procedure above and remove collet nut assembly. (Fig. 5)
- ② The collet and collet nut are secured by a groove in the collet and a flange in the collet nut. To remove the collet hold the collet nut in one hand and push diagonally down on the collet. The collet should be released. (Fig. 6)
- ③ To install the collet, hold the collet at a slight angle, and insert it into the collet nut. (Fig. 7) Press the collet in the collet nut by positioning the collet in the collet nut and pressing down on flat surface (Fig. 6). Be sure to fully engage the latch inside the collet nut into the groove on the collet outer circumference area. (Fig. 8)

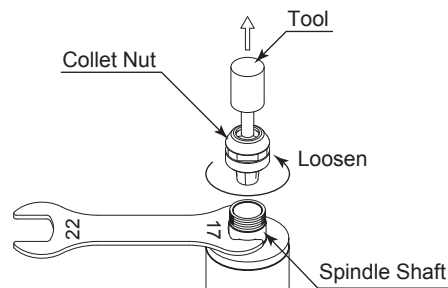

Fig. 5

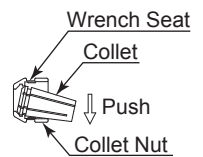

Fig. 6

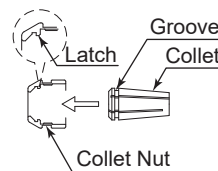

Fig. 7

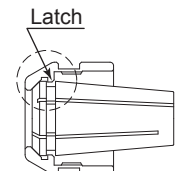

Fig. 8

## 9. CONNECTION OF THE MOTOR CORD

### ⚠ CAUTION

- Before connecting to the Motor Cord Connector, make sure the Main Power Switch in the CONTROLLER is turned OFF. If the Main Power Switch on the CONTROLLER is ON while connecting the Motor Cord Connector, damage may cause to the CONTROLLER.
- Install the Connector Cap (Protective Cap etc.) to prevent damage or contamination to the Motor Cord Connector when not in use.

- ① Remove the Protective Cap of the Motor Cord.

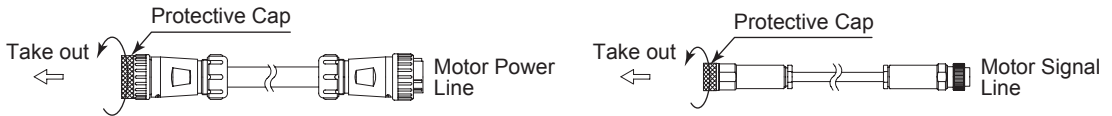

Fig. 9

- ② Ensure the Alignment Pin (Motor Spindle Side) and Alignment Hole (Motor Cord Side) are located (12 o'clock) upward. Carefully insert the alignment pin into the alignment hole and push straight into the Connector of the Motor Cord.



Fig. 10

- ③ Tighten the Connector Nut with clockwise.

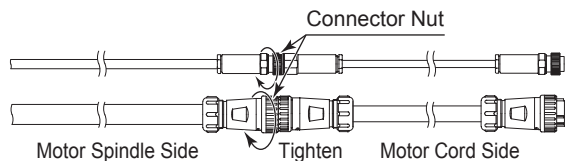

Fig. 11

- ④ Insert the air hose of the Motor Cord Side to the air joint of the Motor Spindle Side.

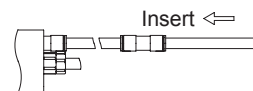

Fig. 12

## 10. INSTALLATION OF THE MOTOR SPINDLE

### ⚠ WARNING

When installing a electric motor spindle to a fixed base, make sure the fixed base is grounded in order to avoid the risk of an electric shock.

**⚠ CAUTION**

- When installing a motor spindle, do not hit, drop or cause shock to the motor spindle. This may cause damage to internal components and result in malfunctions.
- When mounting the motor spindle, be sure to mount within clamping area etched on the motor spindle. If the motor spindle is installed incorrectly, this will cause and damage to the motor spindle.
- Cautions when tightening the securing bolt of the Split Type Holder  
Do not over tighten the bolt. This may cause damage to motor spindle's precision.  
Tighten the bolt until the motor spindle body can not be turned by hand within the fixture.  
Extreme tightening is not necessary or recommended.  
Apply working force and check that the motor spindle is tight before using.

① When mounting a motor spindle, refer to the Clamping Area etched on the motor spindle. (Fig.13)

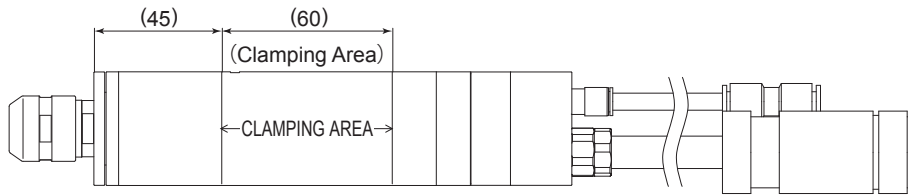

Fig. 13

\* When installing a motor spindle, use a "Grip Ring GR-30 (sold separately (Fig. 14))" recommended. If the Grip Ring GR-30 (sold separately) cannot be used due to the restriction of dimension and space, install as shown in ② below.

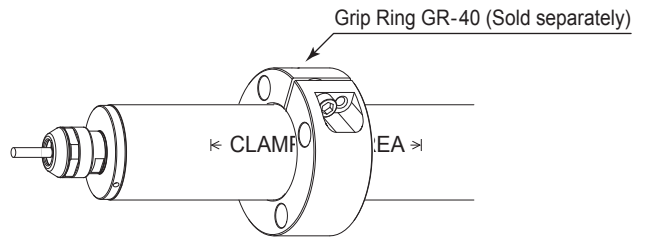

Fig. 14

② When installing a motor spindle to the holder, recommended installation method is shown in Fig. 15. Refer to "③ How to fabricate the Split Type Holder". If this is not possible, install as shown in Fig. 16.

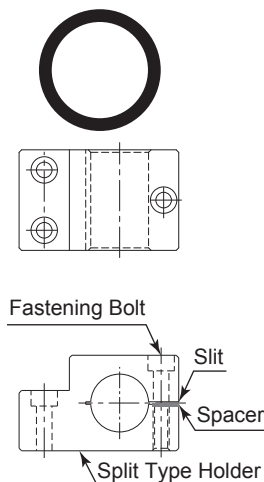

Fig. 15

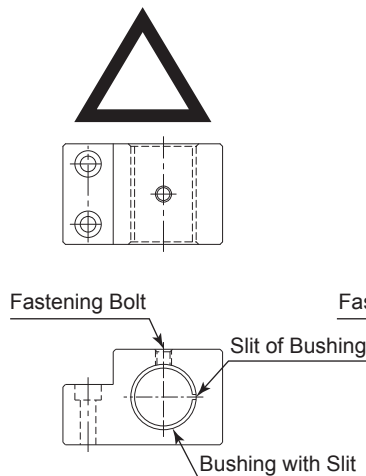

Fig. 16

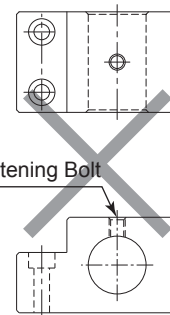

Fig. 17

## ⚠ CAUTION

Do not allow set screws to come directly in contact with the motor spindle body as shown in Fig. 17, as this will result in damage to the motor spindle housing and internal components. When installing, never clamp directly over the bearings, as this will result in bearing damage. (Refer to Fig. 18)

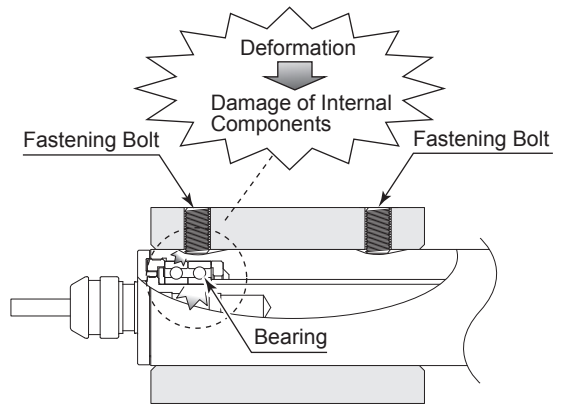

Fig. 18

### ③ How to fabricate the Split Type Holder

- (1) Roughly process (carve) the inside diameter of the Split Type Holder.
- (2) Cut a slit. (Ex. Slit 2mm)
- (3) Twist the Screw for Removal and Broaden the Slit Area.
- (4) Insert spacer (ex t = 2mm) into the Slit Area.
- (5) Loosen the Screw for Removal, and tighten the fastening bolt with the specified torque.
- (6) Finish the Split Type Holder so that the inside diameter of the Split Type Holder is  $\phi 40$  with its tolerance range from  $-0.01\text{mm}$  to  $-0.015\text{mm}$ , and its roundness and cylindricity of less than  $5\mu\text{m}$ .
- (7) When inserting the motor spindle loosen the Fastening Bolt and twist the Screw for Removal, and broaden the Slit Area.

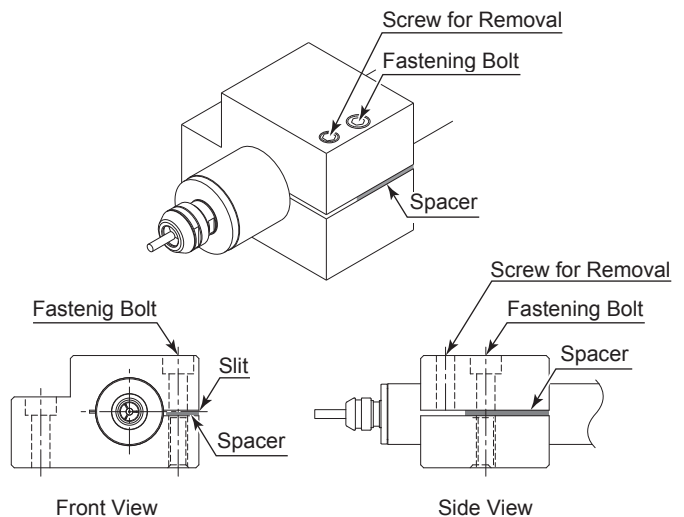

Fig. 19

## ⚠ CAUTION

- How to confirm the tightening standard of the holder by the clamp meter  
Measure the current value of the CONTROLLER's power cord by the clamp meter. Fasten the holder so that the increase in the no-load current value (during rotation at the maximum rotation speed) with the motor spindle fastened is 50mA (for type 200V - 240V) or less, compared to the no-load current value (during rotation at the maximum rotation speed) without fastening the motor spindle. Do not overtighten the Fastening Bolt. It may damage motor spindle's precision and shorten the life of the bearings.
- The final responsibility for ensuring holder's safety for use in a given application is left to the designer of the equipment in which NAKANISHI's motor spindle is installed. NAKANISHI offers motor spindles with a wide variety of capabilities and specifications. Please carefully check the motor spindle's specifications against the requirements of your equipment and verify suitability and safety of the Holder prior to initial use.



## 11. BREAK-IN PROCEDURE

During transportation, storage or installation the grease inside the bearings will settle. If the spindle is suddenly run at high-speed excessive heat will cause bearing damage. After installation, repair, initial operation, or long periods of non operation please follow the break-in procedure detailed in Table 2.

Table 2.

Steps	1	2	3	4
Rotation speed (min <sup>-1</sup> )	10,000	20,000	30,000	40,000
Rotation Time (min)	15	10	10	15
Items to Check	No Abnormal Noises	The motor spindle housing temperature during the break-in process should not exceed 25 degrees C (36 degrees F) above ambient temperature. Should the motor spindle exceed this limit, rest the motor spindle for at least 20 minutes and re-start the break in procedure from the beginning. If the housing temperature rises again and exceeds 25 degrees C (36 degrees F) above ambient temperature, check the motor spindle for proper installation.		The motor spindle housing temperature during the break-in process should not exceed 25 degrees C (36 degrees F) above ambient temperature.

## 12. CAUTIONS IN USING GRINDSTONES AND TOOLS

### CAUTION

The maximum surface speed or rpm is always specified for a grindstone. Do not exceed the maximum speed with reference to the calculating chart below. Always follow the grindstone manufacturers recommendations.

$$\text{Surface Speed (m/s)} = \frac{3.14 \times \text{Diameter (mm)} \times \text{rotation speed (min}^{-1}\text{)}}{1,000 \times 60}$$

- ① The proper surface speed for general grindstones is 10-30m/s.
- ② Do not exceed 13mm of overhang for mounted grindstones as shown in Fig. 20. If the overhang must exceed 13mm, reduce the motor speed in accordance with table 3.
- ③ Do not use tools with bent or broken shanks, cracks or excessive run-out.
- ④ Dress the grindstone prior to use.
- ⑤ For grinding, the maximum depth of cut should not exceed 0.01mm radially or axially. Reciprocate the tool several times after each pass to eliminate tool pressure.
- ⑥ Always operate tools within the allowable recommended speed of the tools. Use of a tool outside of the allowable speed of the tools could cause damage to the spindle and injury to the operator.
- ⑦ Keep the tool shank and collet clean. If contaminants are left in the collet or collet nut, excessive run-out will cause damage to the tool and or spindle.
- ⑧ Do not strike or disassemble the spindle.
- ⑨ Please set the tools to minimize the overhang amount. 13mm is the maximum amount of overhang to maintain high accuracy and safety.

Table 3. Overhang and Speed

Overhang (mm)	Max. Speed (min <sup>-1</sup> )
20	N x 0.5
25	N x 0.3
50	N x 0.1

N=Max. Operating Speed with 13mm overhang.

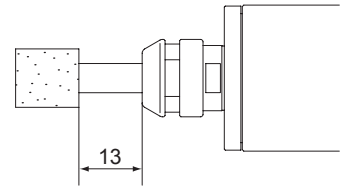

Fig. 20

## 13. TROUBLESHOOTING

If a problem or concern occurs, please check the following prior to consulting your dealer.

Trouble	Cause	Inspection / Corrective Action
Spindle does not run.	The ball bearings are damaged.	Replace the ball bearings. (Return to NAKANISHI dealer service.)
	Motor is broken.	Replace the motor. (Return to NAKANISHI dealer service.)
Overheating during rotation.	Cutting debris has contaminated the ball bearing, and the ball bearing is damaged.	Replace the ball bearings. (Return to NAKANISHI dealer service.)
	Low air pressure.	Check air hose connection and air pressure.
Abnormal vibration or noise during rotation.	Using bent tool.	Replace the tool.
	Cutting debris has contaminated the ball bearing.	Replace the ball bearings. (Return to NAKANISHI dealer service.)
	The ball bearings are worn.	
Tool slippage.	Collet or collet nut are not correctly installed.	Check and clean the collet and collet nut. And, tighten the collet accurately again.
	The collet and the collet nut are worn.	Replace the collet and the collet nut.
High run-out.	The tool is bent.	Change the tool.
	Collet nut is not correctly installed.	Secure the collet and the collet nut correctly.
	The collet and the collet nut are worn.	Replace the collet and the collet nut.
	Inside of the spindle is worn.	Replace the spindle shaft. (Return to NAKANISHI dealer service.)
	Contaminants inside the collet and the collet nut or the spindle.	Clean the collet, collet nut and the inside of the taper and spindle.
	The ball bearings are worn.	Replace the ball bearings. (Return to NAKANISHI dealer service.)

## **14. DISPOSAL OF THE AIR BEARING**

---

When disposal of an Air Bearing Turbine Spindle is necessary, follow the instructions from your local government agency for proper disposal of industrial components.

---

**NAKANISHI INC.** 

700 Shimohinata, Kanuma  
Tochigi 322-8666  
Japan  
[www.nakanishi-inc.com](http://www.nakanishi-inc.com)

**NSK America Corp.**

1800 Global Parkway  
Hoffman Estates  
IL 60192, USA  
[www.nskamericacorp.com](http://www.nskamericacorp.com)

**NSK Europe GmbH** 

Elly-Beinhorn-Strasse 8  
65760 Eschborn  
Germany

**NSK United Kingdom Ltd.**

**UK Responsible Person**  
Office 4, Gateway 1000  
Arlington Business Park, Whittle Way  
Stevenage, SG1 2FP, UK