

## Air Motor Spindle

# PMA - 3013S



## OPERATION MANUAL

OM-K0535E 001

Thank you for purchasing the Air Motor Spindle " PMA - 3013S ". These Air Motor Spindles are designed for drilling, milling, and grinding with a NC lathe or a special purpose machine. The Air Line Kit (with lubricator) and compressor are required to drive these Air Motor Spindles. Read this and all the associated component Operation Manuals carefully before use. Always keep this Operation Manual in a place where a user can referred to for reference at any time.

### 1. CAUTIONS FOR HANDLING AND OPERATION

- Read these warnings and cautions carefully and only use in the manner intended.
- These warnings and cautions are intended to avoid potential hazards that could result in personal injury to the operator or damage to the device. These are classified as follows in accordance with the seriousness of the risk.

Class	Degree of Risk
 <b>WARNING</b>	<b>A safety hazard could result in bodily injury or damage to the device if the safety instructions are not properly followed.</b>
 <b>CAUTION</b>	<b>A hazard that could result in light or moderate bodily injury or damage to the device if the safety instructions are not followed.</b>

#### **WARNING**

- ① This Air Motor Spindle is not a hand tool. It is designed to be used on CNC machines or special purpose machines.
- ② Do not touch the cutting tool while it is running. It is very dangerous.
- ③ Wear safety glasses, dust mask, and use a protective cover around the Air Motor Spindle whenever the Air Motor Spindle is rotating.
- ④ Never operate or handle the Air Motor Spindle until you have thoroughly read the Operation Manuals and safe operation has been confirmed.
  - 1) To prevent injuries / damages, check the Air Motor Spindle and cutting tool for proper installation, before operating the Air Motor Spindle.
  - 2) Before disconnecting the Air Motor Spindle, always turn the control power off and turn the compressed air supply to the Air Line Kit. Then it is safe to remove the Air Motor Spindle.
- ⑤ When installing a tool, tighten the collet correctly and check again the collet before use. Do not over-tighten the collet. This may cause damage to the spindle.
- ⑥ Do not use bent, broken, chipped, out of round or sub-standard tools, as this may cause them to shatter or explode. Tools with fractures or a bent shank will cause injury to the operator. When using a new tool, rotate it in a low speed and increase speed gradually for safety.
- ⑦ Do not exceed the maximum recommended allowable tool speed. For your safety, use speeds below the maximum allowable speed.
- ⑧ Do not apply excessive force. This may cause tool slippage, tool damage, injury to the operator or loss of concentricity and precision.

## CAUTION







- ① Do not drop or hit this Air Motor Spindle, as shock can damage to the internal components.
- ② This Air Motor Spindle uses an oil mist. If oil is not supplied to the Air Motor Spindle, damage to the internal components of the Air Motor Spindle will occur.
- ③ Before use, carefully read " Air Line Kit Operation Manual " regarding the correct connection, operation and cautions when using the Air Line Kit.
- ④ Be sure to clean the collet, the inside of the spindle before replacing the tool. If ground particles or metal chips stick to the inside of spindle or the collet, damage to the collet or spindle can occur due to the loss of precision.
- ⑤ When cleaning an Air Motor Spindle, stop the Air Motor Spindle and remove debris with a soft brush or a cloth. Do not blow air into the end of spindle area (refer to section " 6 - 2 Outside View ") with compressed air as foreign particles or cutting debris may get into the ball bearing.
- ⑥ Always clean the tool shank before installing the tool in the spindle.
- ⑦ When sizing the correct collet size to the tool shank diameter, a tolerance of  $+0 \sim -0.01\text{mm}$  is strongly recommended.  
A tool shank within the  $+0 \sim -0.1\text{mm}$  range is mountable, however, this may cause poor concentricity and or insufficient tool shank gripping force.
- ⑧ Operating the Air Motor Spindle in low Lubricant conditions will cause low rotation speed, damage to the internal components and shorter life of the Air Motor Spindle.
- ⑨ Be sure to drain moisture and condensation from the Air Line Kit (air filter bowl) regularly to avoid moisture being carried to the Air Motor Spindle. This may cause damage to the Air Motor Spindle.
- ⑩ Select suitable products or tools for all applications. Do not exceed the capabilities of the Air Motor Spindle or tools.
- ⑪ Do not stop the supplied cooling air to the air motor while coolant spray is being applied to the cutting tool.  
Removing the air pressure from the air motor causes a loss of purging, allowing the Air Motor Spindle to ingest coolant. This will cause damage to the Air Motor Spindle.
- ⑫ Carefully direct coolant spray directly on the tool. Do not spray directly on the Air Motor Spindle body. If large amount spray directly on the Air Motor Spindle, it may cause excess load of the Air Motor Spindle rotation with loss of durability to the Air Motor Spindle.
- ⑬ Stop working immediately when abnormal rotation or unusual vibration are observed. Immediately, please check the content of section " 13. TROUBLESHOOTING ".
- ⑭ Always check if the tool, collet, connection hose and supply and exhaust air / oil hose for damaged before and after operating.
- ⑮ If the collet show signs of wear or damage, replace it before a malfunction or additional damage occurs.
- ⑯ After installation, repair, initial operation, or long periods of non operation, please refer to section " 11. BREAK-IN PROCEDURE " detailed in Table. 2. When checking the Air Motor Spindle, no vibration or unusual sound should be observed during rotation.
- ⑰ Do not disassemble, modify or attempt to repair this Air Motor Spindle. Additional damage will occur to the internal components. Service must be performed by NSK NAKANISHI or an authorized service center.
- ⑱ When using this Air Motor Spindle for mass production, please consider the purchase of an additional Air Motor Spindle to be used as a back-up in case of emergency.
- ⑲ Securely connect the compressor supply connection hose to the Air Line Kit, and, connect the supply and exhaust air / oil hose to the Air Line Kit and the Air Motor Spindle to avoid accidental disconnection during use.

## 2. BASIC PACKAGE

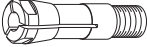
When opening the package, check if it includes all items listed in " Table. 1 Packing List Contents ".

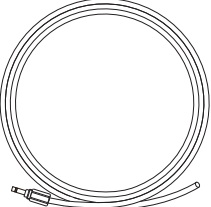
In the event of any shortage, please contact either NAKANISHI (see the " 4. CONTACT US " section) or your local dealer.

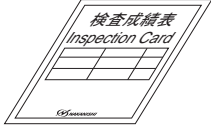
Table. 1 Packing List Contents

<p>Air Motor Spindle • • 1pc.</p> 	<p>Collet <math>\phi 3.0\text{mm}</math> (CHSS - 3.0) or <math>\phi 3.175\text{mm}</math> (CHSS - 3.175) • • 1pc.* (For U.S. market <math>\phi 3.175\text{mm}</math> (CHSS - 3.175))</p> 	<p>Wrench (5.1 x 7), (6.1 x 8) • • 1pc. Each.</p> 
<p>Supply Air / Oil Hose (K - 215 : 2 m) (with Filter Joint (FJ - 01)) • • 1pc.</p> 	<p>Exhaust Air / Oil Hose (K - 256 : 0.1 m) (with Silencer (K - 209)) • • 1pc.</p> 	<p>Inspection Card • • 1pc.</p> 
<p>Operation Manual • • 1set</p> 		

\*The collet is attached to the Air Motor Spindle.

## 3. WARRANTY

We provide a limited warranty for our products. We will repair or replace the products if the cause of failure is due to the following manufactures defects. Please contact us or your local distributor for details.

- ① Defect in manufacturing.
- ② Any shortage of components in the package.
- ③ Where damaged components are found when initially opening the package.  
(This shall not apply if the damage was caused by the negligence of a customer.)

## 4. CONTACT US

For your safety and convenience when purchasing our products, we welcome your questions.  
If you have any questions about operation, maintenance and repair of the product, please contact us.

### Contact Us

- For U.S. Market
  - Company Name : **NSK America Corp**  
Industrial Div.
  - Business Hours : 8:30am to 17:00pm (CST)  
(closed Saturday, Sunday and Public Holidays)
  - U.S. Toll Free No. : 800-585-4675
  - Telephone No. : 847-843-7664
  - Fax No. : 847-843-7622
  - Web Address : www.nskamericacorp.com

- For Other Markets
  - Company Name : **NAKANISHI INC.** 
  - Business Hours : 8:00am to 17:00pm  
(closed Saturday, Sunday and Public Holidays)
  - Telephone No. : +81 (0) 289-64-3520
  - e-mail Address : webmaster-ie@nsk-nakanishi.co.jp

## 5. FEATURES

- ① The Air Motor Spindle housing is made from precision ground, hardened, stainless steel (SUS) with an outside diameter of  $\phi 30\text{mm}$ .
- ② No heat is generated for long continuous use due to air driven operation.
- ③ By mounting a silencer on the back exhaust air / oil hose, the quiet operation of air turbine is remarkably improved.
- ④ Various sizes of collets are available CHSS 1.0mm - 3.175mm. Standard collet is CHSS 3.0mm or CHSS 3.175mm.  
(For U.S. market CHSS 3.175mm).

## 6. SPECIFICATIONS AND DIMENSIONS

### 6 - 1 Specifications

Model	PMA - 3013S	PMA - 3013S - RA
Motor Rotation Speed	13,300min <sup>-1</sup> (rpm) (at 0.5MPa (72.5psi) Air Pressure)	
Spindle Accuracy	Less than 3 $\mu\text{m}$	
Reduction Ratio	1 / 1.5	
Appropriate Air Pressure	0.3 - 0.5MPa (43.5 - 72.5psi)	
Air Consumption	215N $\ell$ / min	
Supply and Exhaust Air / Oil Hose Dimensions	Supply : I.D. $\phi 4.0\text{mm}$ x O.D. $\phi 6.0\text{mm}$ Length : 2m Exhaust : I.D. $\phi 6.0\text{mm}$ x O.D. $\phi 8.0\text{mm}$ Length : 0.1m	
Weight	520g	
Noise Level at 1m distance	Less than 75dB (A)	

	Temperature	Humidity	Atmospheric Pressure
Operation Environment	0 - 40° C	MAX.75% (No condensation)	800 - 1,060hPa
Transportation and Storage Environment	-10 - 50° C	10 - 85%	500 - 1,060hPa

Collet (CHSS- □□ )	$\phi 1.0\text{mm}$ , $\phi 1.5\text{mm}$ , $\phi 2.0\text{mm}$ , $\phi 2.35\text{mm}$ , $\phi 2.5\text{mm}$ , $\phi 3.0\text{mm}$ , $\phi 3.175\text{mm}$
--------------------	--

**⚠ CAUTION**

The standard length of supply air / oil hose is 2m, and exhaust air / oil hose is 0.1m. When the supply and exhaust air / oil hose is longer than the standard length, the rotating speed is decreased.

**6 - 2 Outside View**

① PMA - 3013S

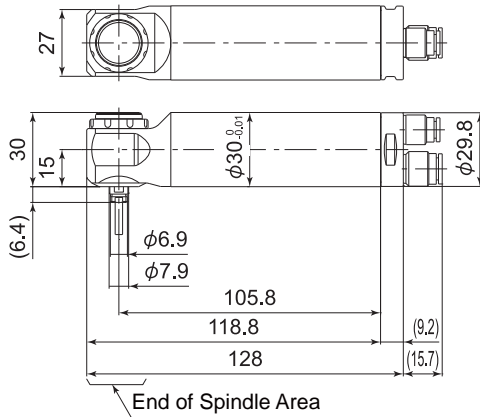

Fig. 1

② PMA - 3013S - RA

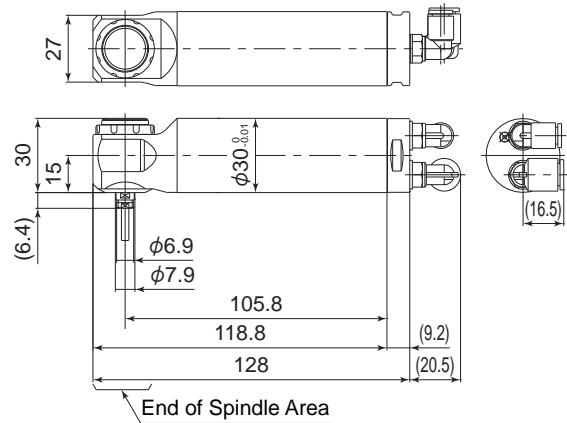

Fig. 2

\*90° Angle type airjoint is free to rotate for the direction of Air flow.

**6 - 3 Torque Characteristics**

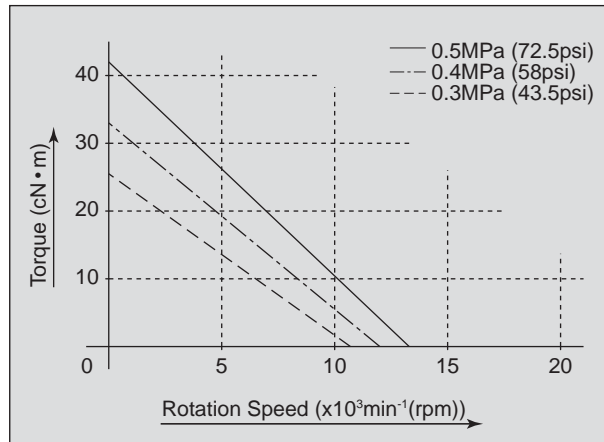

Fig. 3

**7. CHANGING THE TOOL**

**⚠ CAUTION**

Do not tighten the collet without inserting a tool or dummy bur as this will result in damage to the collet.

**RECOMMENDATION**

Please set the cutting tools to minimize the overhang amount. 13mm is the maximum amount of overhang to maintain high accuracy and safety.

- ① Set the provided 7mm wrench on the spindle shaft.
- ② Place the provided 6.1mm wrench on the collet and turn it counterclockwise to loosen the collet and remove the tool.
- ③ Clean the collet, then insert the new tool and tighten the collet by turning clockwise. Do not over-tighten.

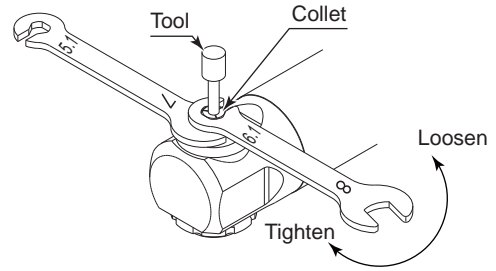

Fig. 4

## 8. REPLACING THE COLLET

- ① Remove the tool according to the section " 7. CHANGING THE TOOL " procedure above (Fig. 5).
- ② Place the provided 7mm wrench on the spindle shaft, and turn the top of the collet counterclockwise to remove the collet (Fig. 5).
- ③ Install the new collet into the spindle by turning it clockwise.

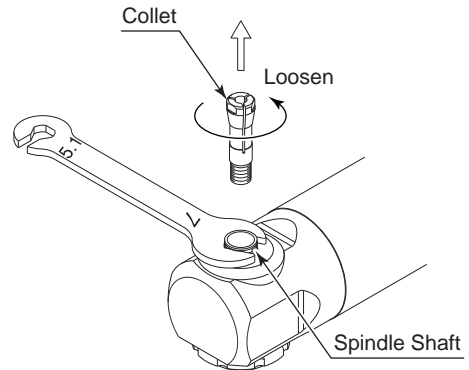

Fig. 5

## 9. INSTALLATION OF THE AIR MOTOR SPINDLE

### ⚠ WARNING

When installing an Air Motor Spindle to a machine, make sure the machine is grounded in order to avoid the risk of an electric shock.

### ⚠ CAUTION

- When installing an Air Motor Spindle, do not hit, drop or cause shock to the Air Motor Spindle. This may cause damage to internal components and result in malfunctions.
- When mounting the Air Motor Spindle, be sure to secure within Clamping Area etched on the Air Motor Spindle O.D. If the Air Motor Spindle is installed incorrectly, damage to the internal components is possible.
- Cautions when tightening the securing bolts on to a Split Type Holder  
Do not over-tighten the bolt. This will cause damage to Air Motor Spindle's precision. Tighten the bolt until the Air Motor Spindle body can not be rotated by hand within the fixture. Extreme tightening is not necessary or recommended.  
Apply working force and check that the Air Motor Spindle is tight before using.

- ① When mounting an Air Motor Spindle, refer to the Clamping Area etched on the Air Motor Spindle (Fig. 6).

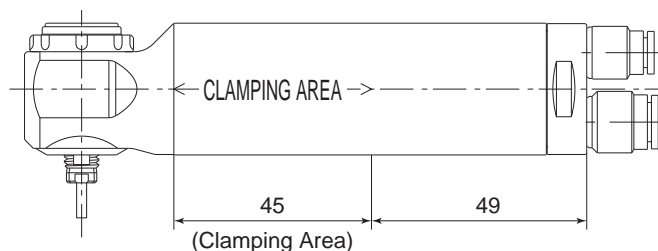

Fig. 6

\* When installing the Air Motor Spindle, it is recommended to use a " GR - 30 Grip Ring (sold separately (Fig. 7)) ". If the GR - 30 Grip Ring cannot be used due to the restriction of dimension and space, install as shown in ② below.

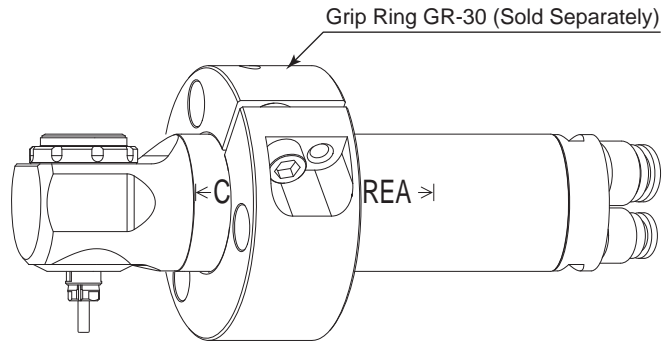

Fig. 7

② When installing an Air Motor Spindle to the holder, recommended installation method is shown Fig. 8. Refer to " ③ How to fabricate the Split Type Holder ". If this is not possible, install as shown in Fig. 9.

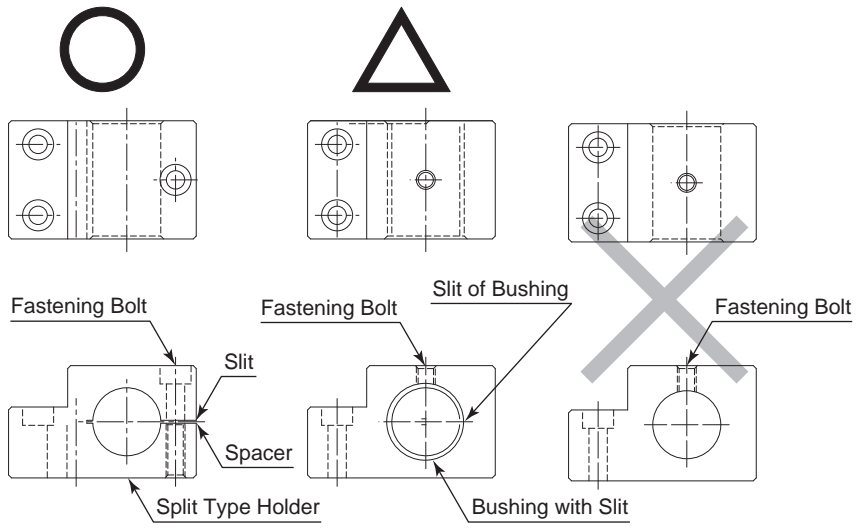

Fig. 8

Fig. 9

Fig. 10

**CAUTION**

Do not allow set screws to come directly in contact with the Air Motor Spindle body as shown in Fig. 10, as this will result in damage to the Air Motor Spindle housing and internal components.  
 When installing, never clamp directly over the bearings, as this will result in bearing damage (Refer to Fig. 11).

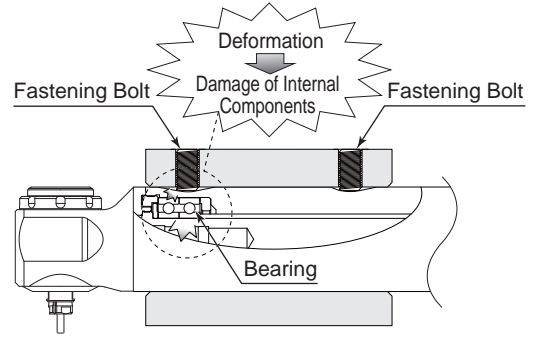

Fig. 11

- ③ How to fabricate the Split Type Holder
- (1) Rough bore the inside diameter of the Split Type Holder.
  - (2) Cut a slit. (Ex. Slit 2mm wide.)
  - (3) Tighten the Screw for Removal and Force Open the Slit Area.
  - (4) Insert a spacer (Ex. thickness = 2mm) into the Slit Area.
  - (5) Loosen the Screw for Removal, and tighten the fastening bolt with its specified (recommended) torque.
  - (6) Finish the Split Type Holder so that the inside diameter of the Split Type Holder is  $\phi 30$  with its tolerance range from - 0.01mm to - 0.015mm, and its roundness and cylindricity of less than  $5\mu\text{m}$ .
  - (7) When inserting the Air Motor Spindle loosen the Fastening Bolt, and tighten the Screw for Removal, widening the Slit Area.

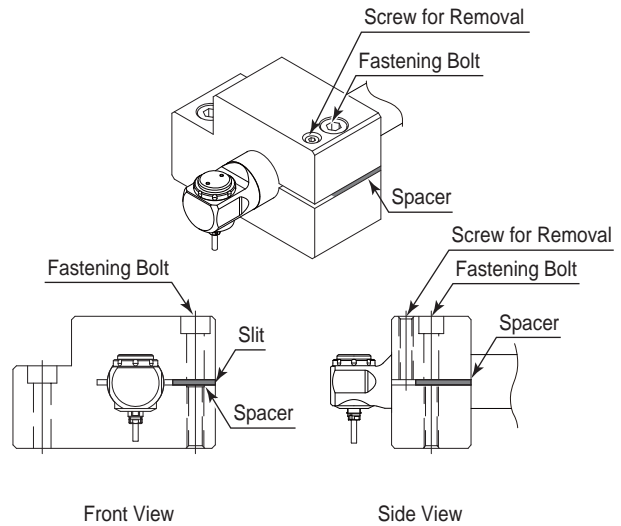

Fig. 12

**⚠ CAUTION**

The final responsibility for ensuring holder's safety for use in a given application is left to the designer of the equipment in which NAKANISHI's Air Motor Spindle is installed. NAKANISHI offers Air Motor Spindle with a wide variety of capabilities and specifications. Please carefully check the Air Motor Spindle's specifications against the requirements of your equipment and verify suitability and safety of the Holder prior to initial use.

## 10. CONNECTION TO THE AIR LINE KIT

**⚠ CAUTION**

Make sure to turn the compressed air supply to the Air Line Kit OFF, before replacing the Lubricating Oil or draining the water in Lubricating Oil.

- ① Connect the Filter Joint of the supply air / oil hose to the Secondary Joint (  $\phi 6$  One - Touch Joint) of the Air Line Kit (Fig. 13 ① ).
- ② Fill Oil Reservoir through the Oil Filler Cap with recommended NAKANISHI Lubricating Oil (K - 211 : Air Line Kit's Standard Accessories) to Upper Limit. Disconnect from air supply prior to opening Oil Filler Cap. Do not over or under fill.
- ③ Connect the connection hose (Air Line Kit's Standard Accessories) to the Primary Joint of the Air Line Kit and Compressor (Fig. 13 ② ).
- ④ Supply air from the air compressor and turn the Regulator Knob to set air pressure between 0.3 - 0.5 MPa (43.5 - 72.5psi).
- ⑤ Turn the ON / OFF Valve and rotate the Air Motor Spindle with recommended proper air pressure. Adjust the Oil Drip Rate to the recommended volume which is 1 to 3 drops / min. (Commercially Air Line Kit is same Oil Drip Rate).  
\* Refer to the Operation Manual of the Air Line Kit for detailed information.
- ⑥ Be sure to adjusted to proper Oil Drip Rate before using the Air Motor Spindle.

**Lubricating Oil**

Use ISO VG15 Liquid Paraffin (Shell Ondina Oil #15) in the Air Line Kit lubricator bowl. (For U.S.A. specification, use Chevron Superla #9).

Model
• Lubricating Oil (K - 211) 70cc
• Lubricating Oil (K - 202) 1 ℓ



## ⚠ CAUTIONS IN USING AIR LINE KIT

- When connecting the Compressor and Air Line Kit, recommended install the air filter or air dryer to between Compressor and Air Line Kit in order to supply clean dry air to the Air Motor Spindle. Using compressed air containing excessive moisture could result in malfunction or failure of the Air Motor Spindle. If excessive moisture or condensation are found in Air Filter Bowl (Filter Regulator Bowl), it will be necessary to install a dryer and larger air filter on the Primary Joint side of the Air Line Kit to prevent and remove excessive moisture.
- Connect the input air supply connection hose and supply air / oil hose securely to avoid accidental disconnection during use. Input air pressure should never exceed 1.0MPa (145psi). Air pressure exceeding 1.0MPa (145psi) may cause the supply connection hose and or air / oil hose supply to rupture.
- Make sure operation air pressure is less than 1.0MPa (145psi) before connecting the input supply connection hose and air / oil supply hose. If operation air pressure is exceeds 1.0MPa (145psi), injury to the operator may occur by accidental disconnection before or during use.
- Before use, carefully read " Air Line Kit Operation Manuals " regarding the correct connection, operation and cautions when using the Air Line Kit.

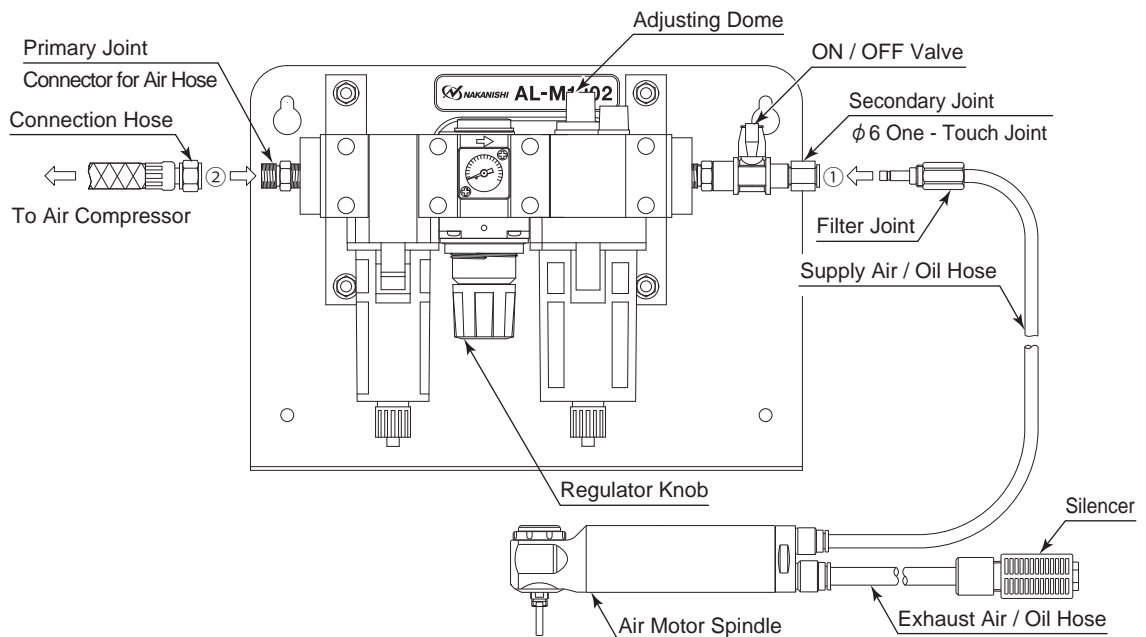

Fig. 13 Connection of Air Line Kit " AL - M1202 (Sold Separately) "

## 11. BREAK-IN PROCEDURE

During transportation, storage or installation, the grease inside the bearings will settle. If the Air Motor Spindle is suddenly run at high-speed, the grease will be ejected from the bearings, causing excessive heat that will cause bearing damage. After installation, repair, initial operation, or long periods of non operation, please follow the break-in procedure detailed in Table. 2.

Table. 2

Steps		1	2	3	4	5
Air Pressure	MPa	0.1	0.2	0.3	0.4	0.5
	psi	14.5	29	43.5	58	72.5
Rotation Time (min)		15	10	10	10	15
Items to Check		No Abnormal Noises	The Air Motor Spindle housing temperature during the break-in process should not exceed 20 degrees C (36 degrees F) above ambient temperature. Should the Air Motor Spindle exceed this limit, rest the Air Motor Spindle for at least 20 minutes and re-start the break in procedure from the beginning. If the housing temperature rises again and exceeds 20 degrees C (36 degrees F) above ambient temperature, check the Air Motor Spindle for proper installation.			The Air Motor Spindle housing temperature during the break-in process should not exceed 20 degrees C (36 degrees F) above ambient temperature.

## 12. CAUTIONS WHEN USING GRINDSTONES AND TOOLS

### ⚠ CAUTION

The maximum surface speed or rpm is always specified for a grindstone. Do not exceed the maximum speed with reference to the calculating chart below. Always follow the grindstone manufacturer's recommendations.

$$\text{Surface Speed (m / s)} = \frac{3.14 \times \text{Diameter (mm)} \times \text{Rotation Speed (min}^{-1}\text{) (rpm)}}{1,000 \times 60}$$

- ① The proper surface speed for general grindstones is 10 - 30m / s.
- ② Do not exceed 13mm of overhang for mounted grindstones as shown in Fig. 14. If the overhang must exceed 13mm, reduce the Air Motor Spindle speed in accordance with Table. 3.
- ③ Dress the grindstone prior to use.
- ④ Do not use cutting tools with bent or broken shanks, cracks or excessive run-out.
- ⑤ For grinding, the maximum depth of cut should not exceed 0.01mm radially or axially. Reciprocate the tool several times after each pass to eliminate tool pressure.
- ⑥ Always operate cutting tools within the allowable recommended speed of the cutting tools. Use of a cutting tool outside of the allowable speed of the cutting tools could cause damage to the spindle and injury to the operator.
- ⑦ Keep the cutting tool shank and collet clean. If contaminants are left in the collet, excessive run-out will cause damage to the cutting tool and or spindle.
- ⑧ Do not strike or disassemble the Air Motor Spindle.
- ⑨ Please set the cutting tools to minimize the overhang amount. 13mm is the maximum amount of overhang to maintain high accuracy and safety.

Table. 3 Overhang and Speed

Overhang (mm)	Max. Speed (min <sup>-1</sup> ) (rpm)
20	N x 0.5
25	N x 0.3
50	N x 0.1

\* N = Max. Operating Speed with 13mm overhang.

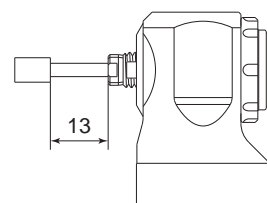



Fig. 14

## 13. TROUBLESHOOTING

If a problem or concern occur, please check the following items prior to consulting your dealer.

Trouble	Cause	Inspection / Corrective Action
Air Motor Spindle does not rotate or rotate smoothly.	Air flow does not reach the Air Motor Spindle.	Check if input supply connection hose or air / oil supply hose is broken, bent or disconnected.
		Check connection of the input supply connection and air / oil supply hoses.
		Check the compressor power supply and the air compressor output.
		Check the Regulator and set to the correct air pressure. Check all connections input supply and air / oil supply hose.
	The spindle ball bearings have been damaged.	Replace the ball bearings. (Return to NAKANISHI dealer service.)
	The Air Motor Spindle has been damaged by for no Lubricating Oil.	Replace the motor. (Return to NAKANISHI dealer service.)
Air Motor Spindle rotation speed is too slow.	The connection hose or air / oil supply hose have been damaged.	Replace the input supply and or air / oil supply hoses.
	Poor connection of input supply or air / oil supply hose.	Check all threaded joints and re-tighten if necessary.
Air Motor Spindle rotation speed is too slow.	Low air pressure.	Check the Compressor, Air Circuit, and Regulator.
	Low Lubricating Oil.	Check lubricator for proper lubricant level. Set the Oil Drip Rate from 1 to 3 drops / min.
	No Lubricating Oil.	Clean inside of the motor use the Lubricating Oil. Removing the Filter Joint from Air Line Kit, supply a small amount of Lubricating Oil directly into the Filter Joint. Afterwards, supply air pressure and rotate the Air Motor Spindle. Flush dirt in the motor and repeatedly do this work about three times. When the improvement is not seen, return to NAKANISHI dealer service.
	Water, dirt and debris are collected in the Air Filter.	Drain water, dirt and debris from the Air Filter Bowl.
	Water in Lubricating Oil reservoir.	Drain water from Lubricating Oil reservoir and replace with clean Lubricating Oil.
Oscillating Air Motor Spindle rotation.	Lubricator inclined or upside down. 	Inclined or upside down lubricator will flood spindle with lubricating Oil.
	Excessive Oil Drip Rate flooding the bearings.	Oil drip rate exceeds the recommended amount. Adjust for the proper Oil Drip Rate.
	Over filled lubricator. 	Drain the Lubricating Oil from Reservoir to meet indicated levels. Excess lubricant will flood spindle. → Draining the lubricating oil until upper limit below by opening the Drain Valve.
Overheating during rotation.	Cutting debris has contaminated the ball bearings, and the ball bearings are damaged.	Replace the ball bearings. (Return to NAKANISHI dealer service.)
Abnormal vibration or noise during rotation.	The tool shank is bent.	Replace the tool.
	Cutting debris has contaminated the ball bearing.	Replace the ball bearings. (Return to NAKANISHI dealer service.)
	The spindle ball bearings have been damaged.	

Trouble	Cause	Inspection / Corrective Action
Tool slippage.	Collet is not correctly installed.	Check and clean the collet. Reinstall the collet.
	The collet is worn.	Replace the collet.
High run-out.	The tool is bent.	Change the tool.
	Collet is not correctly installed.	Secure the collet correctly.
	The collet is worn.	Replace the collet.
High run-out.	Inside of the spindle is worn.	Replace the spindle shaft. (Return to NAKANISHI dealer service.)
	Contaminants inside the collet or the spindle.	Clean the collet and the inside of the taper and spindle.
	The spindle ball bearings have been damaged.	Replace the ball bearings. (Return to NAKANISHI dealer service.)

Refer to the Air Line Kit (AL - M1202) Operation Manual.

## 14. DISPOSAL OF THE AIR MOTOR SPINDLE

When disposal of an Air Motor Spindle is necessary, follow the instructions from your local government agency for proper disposal of industrial components.