

Brushless Motor

EM - 2350J

OPERATION MANUAL

Thank you for purchasing the Brushless Motor "EM - 2350J". The E2280 CONTROLLER, Spindle, Motor Cord and Air Line Kit are required to drive this Brushless Motor. Read this and all the associated component Operation Manuals carefully before use. Always keep this Operation Manual in a place where a user can referred to for reference at any time.

1. CAUTIONS FOR HANDLING AND OPERATION

- Read these warnings and cautions carefully and only use in the manner intended.
- These warnings and cautions are intended to avoid potential hazards that could result in personal injury to the operator or damage to the device. These are classified as follows in accordance with the seriousness of the risk.

Class	Degree of Risk
WARNING	A safety hazard could result in bodily injury or damage to the device if the safety instructions are not properly followed.
CAUTION	A hazard that could result in light or moderate bodily injury or damage to the device if the safety instructions are not followed.

WARNING

- This Brushless Motor is not a hand tool. It is designed to be used on CNC machines or special purpose machines.
- Do not touch the cutting tool while it is running. It is very dangerous.
- Wear safety glasses, dust mask, and use a protective cover around the Brushless Motor whenever the Brushless Motor is rotating.
- Never connect, disconnect or touch the Power Cord or Motor Cord Plug with wet hands. This may cause an electric shock.
- Never operate or handle the Brushless Motor and spindle until you have thoroughly read the Operation Manuals and safe operation has been confirmed.
 - To prevent injuries / damages, check the Brushless Motor, spindle and cutting tool for proper installation, before operating the Brushless Motor and spindle.
 - Before disconnecting the Brushless Motor and spindle, always turn the control power off and turn the compressed air supply to the CONTROLLER off. Then it is safe to remove the Brushless Motor and spindle.
- Whenever installing a Brushless Motor to a fixed metal base, ensure that the fixed metal base is grounded in order to avoid risk of an electric shock.

CAUTION

- Do not drop or hit this Brushless Motor, as shock can damage to the internal components.
- When cleaning a Brushless Motor, stop the Brushless Motor and remove debris with a soft brush or a cloth. Do not blow air into the Brushless Motor with compressed air as foreign particles or cutting debris may get into the ball bearing.
- Select suitable products or tools for all applications. Do not exceed the capabilities of the Brushless Motor or tools.
- Do not stop the supplied cooling air to the Brushless Motor during operation of the machine. Removing the air pressure from the Brushless Motor causes a loss of purging, allowing the Brushless Motor to ingest coolant and debris. This will cause damage to the Brushless Motor.
- Stop working immediately when abnormal rotation or unusual vibration are observed. Immediately, please check the content of section " 9. TROUBLESHOOTING ".
- Always check if the connection hose and supply air hose for damaged before and after operating.
- After installation, repair, initial operation, or long periods of non operation, please carry out break-in as follow. Start rotating slowly and over a short period of 15 - 20 minutes, increase speed gradually until Maximum Allowable Motor Rotation Speed.
- Do not disassemble, modify or attempt to repair this Brushless Motor. Additional damage will occur to the internal components. Service must be performed by NSK NAKANISHI or an authorized service center.
- When using this Brushless Motor for mass production, please consider the purchase of an additional Brushless Motor to be used as a back-up in case of emergency.
- Securely connect the compressor supply connection hose to the Air Line Kit, and connect the air hose to the Air Line Kit, the CONTROLLER and the Brushless Motor to avoid accidental disconnection during use.

2. BASIC PACKAGE

When opening the package, check if it includes all items listed in " Table. 1 Packing List Contents ". In the event of any shortage, please contact either NAKANISHI (see the " 4. CONTACT US " section) or your local dealer.

Table. 1 Packing List Contents

Brushless Motor • • 1pc.	Wrench (20 x 24) • • 1pc.	Operation Manual • • 1set

3. WARRANTY

We provide a limited warranty for our products. We will repair or replace the products if the cause of failure is due to the following manufactures defects. Please contact us or your local distributor for details.

- Defect in manufacturing.
- Any shortage of components in the package.
- Where damaged components are found when initially opening the package.
(This shall not apply if the damage was caused by the negligence of a customer.)

4. CONTACT US

For your safety and convenience when purchasing our products, we welcome your questions. If you have any questions about operation, maintenance and repair of the product, please contact us.

Contact Us

- For U.S. Market

Company Name	: NSK America Corp
Industrial Div.	
Business Hours	: 8:30am to 17:00pm (CST) (closed Saturday, Sunday and Public Holidays)
	: 800-585-4675
U.S. Toll Free No.	: 847-843-7664
Telephone No.	: 847-843-7622
Fax No.	: 847-843-7622
Web Address	: www.nskamericacorp.com

- For Other Markets

Company Name	: NAKANISHI INC.
Industrial Div.	
Business Hours	: 8:00am to 17:00pm (closed Saturday, Sunday and Public Holidays)
	: +81 (0) 289-64-3520
Telephone No.	: +81 (0) 289-64-3520
e-mail Address	: webmaster-ie@nsk-nakanishi.co.jp

5. FEATURES

- The Brushless Motor housing is made from precision ground, hardened, stainless steel (SUS) with an outside diameter of $\phi 22.8$ mm.
- Excellent durability and high reliability are obtained by using a high-speed Brushless Motor, which eliminates the need for brush replacement and frequent maintenance.
- A quick disconnect cord is available for easy Brushless Motor removal.
- The maximum output is 200W.
- An Air-cooling system with a small volume of air (30 ℓ / min) is used to prevent heat buildup and allows for long continuous operation.

6. SPECIFICATIONS AND DIMENSIONS

6 - 1 Specifications

Model	EM - 2350J
Motor Rotation Speed	1,000 - 50,000min ⁻¹ (rpm)
Max. Output	200W
Quick Disconnect Cord Length	0.3m
Weight	260g (Motor Cord included)
Noise Level at 1m distance	Less than 70dB (A)

Operation Environment	Temperature 0 - 40°C	Humidity MAX.75% (No condensation)	Atmospheric Pressure 800 - 1,060hPa
Transportation and Storage Environment	-10 - 50°C	10 - 85%	500 - 1,060hPa

<Option>

Motor Cord	EMCD - 2350J - □ M	Cord Length : 3.7m, 5.7m, 7.7m
*Note 1		(The Air Hose ($\phi 4$ mm) of the same length is included.)

* Note 1: Motor Cord is sold separately.
Please select the suitable motor cord length for your application.

6 - 2 Outside View

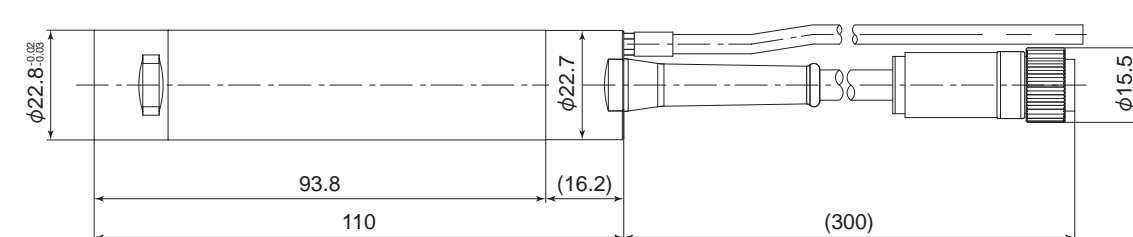

Fig. 1

6 - 3 Torque Characteristics

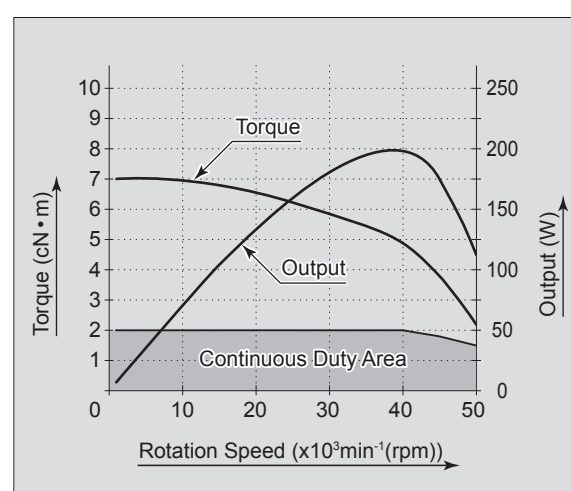

Fig. 2

7. CONNECTION OF MOTOR CORD

CAUTION

- Before connecting the Motor Cord to the CONTROLLER, verify the Main Power Switch on the CONTROLLER is turned OFF. If the Main Power Switch on the CONTROLLER is ON while connecting the Motor Cord, damage to the CONTROLLER is possible.
- Install the Protective Cap with strap to prevent damage or contamination to the Motor Cord Connector when not in use.

- Remove the Protective Cap with strap on the Motor Cord Connector. Keep the Cap attached to the cable to keep the connector pins safe and clean when not in use.

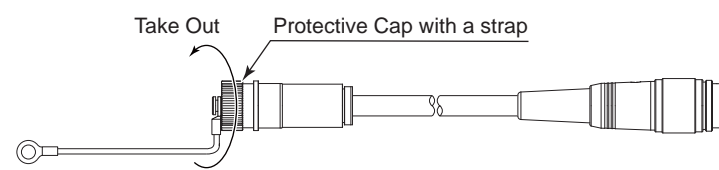

Fig. 3

- Carefully insert the Alignment Hole on the Motor Cord Connector into the Alignment Pin on the Motor Cord Connector, then push straight into the Motor Cord Connector.

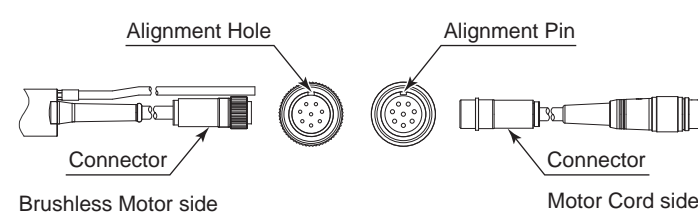

Fig. 4

- Tighten the Connector Nut with clockwise.

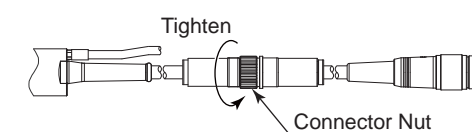

Fig. 5

- Remove the protective air plug.

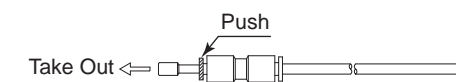

Fig. 6

- Insert the provided air hose.

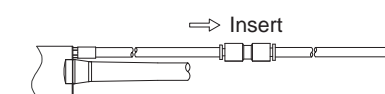

Fig. 7

8. CONNECTION OF THE MOTOR TO THE SPINDLE

CAUTION

Make sure your hands are clean before handling the spindle and the Brushless Motor. This is critical in preventing contaminants from entering the Brushless Motor or spindle.

Align the thread on the front end of the Brushless Motor and the rear of the spindle, and turn the spindle clockwise. If the drive shaft of the Brushless Motor does not engage properly to the drive dog on the spindle, it may only turn approximately two threads before stopping. DO NOT FORCE THEM TOGETHER. Loosen the spindle from the Brushless Motor, rotate the spindle shaft by hand then re-try. The drive shaft and the drive dog must be fully engaged. When fully engaged, secure the spindle and Brushless Motor using the provided 20mm wrench (Fig. 8).

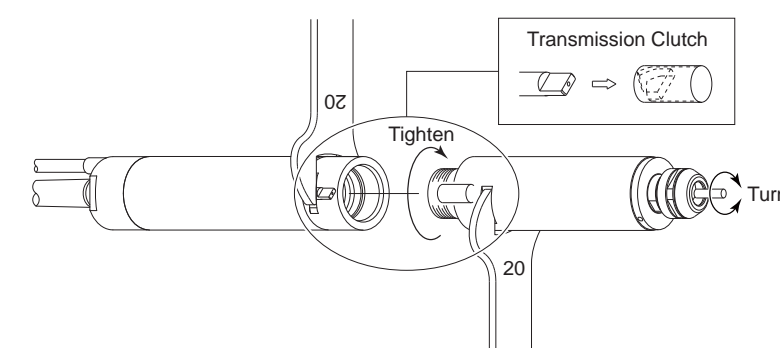

Fig. 8

9. TROUBLESHOOTING

If a problem or concern occur, please check the following items prior to consulting your dealer.

Trouble	Cause	Inspection / Corrective Action
Brushless Motor does not rotate.	Power is not supplied.	<ul style="list-style-type: none"> Make sure to turn ON the Main Power Switch on the front of the CONTROLLER. Check that the power cord connector is correctly inserted into the Main Power Inlet of the CONTROLLER. Check if a fuse is blown.
	Motor Cord is not connected to the Brushless Motor or CONTROLLER.	Correctly connect the Motor Cord to the Brushless Motor or CONTROLLER.
	Control Button (CTRL) is set to Auto mode but trying to manually start with the START / STOP Button (START / STOP) on the Control Panel.	Set the Control Button (CTRL) on the Control Panel to Manual Mode. Re-try starting by using the START / STOP Button (START / STOP) on the Control Panel.
	Control Button (CTRL) is set to Auto mode but trying to manually start with the START / STOP Button (START / STOP) on the Control Panel.	Start with an External Command Signal or set the Control Button (CTRL) on the Control Panel to Manual mode (When Start with an External Command Signal. (Refer to " 16 - 1 (1) Details of External Input / Output Connector A ③ Signal Table. 6 Pin No. 14 " of the E2280 CONTROLLER Operation Manual).
Emergency Stop Signal is " OFF (Open) ".		Check the setting of parameter P_{1b} . (Refer to " 18 - 4 ⑨ P_{1b} Selection of Emergency Stop Function " of the E2280 CONTROLLER Operation Manual).
	An Error has occurred (Error LED is lit).	Check the " 17 - 3 Resetting System after Error Codes Table. 9 " in the E2280 CONTROLLER Operation Manual. Error will not be released until cause of the error has been removed.
Cannot increase or decrease the motor rotation speed.	Low Air Pressure (A1 or E7).	Adjust to the air pressure 0.25 - 0.3MPa (36.3 - 43.5psi).
	When using Motor No. 1 : Motor Fixed Speed is set in the P_{3} or P_{5} parameter. When using Motor No. 2 : Motor Fixed Speed is set in the P_{4} or P_{6} parameter.	Cancel the parameters for " Fixed Motor Speed Setting " and " Maximum Motor Speed Setting ". When using Motor No. 1 : Refer to " 18 - 4 ④ P_{3} Setting Fixed Motor No. 1 Speed " or " 18 - 4 ⑤ P_{5} Setting Maximum Motor No.1 Speed " in the E2280 CONTROLLER Operation Manual. When using Motor No. 2 : Refer to " 18 - 4 ④ P_{4} Setting Fixed Motor No.2 Speed " or " 18 - 4 ⑥ P_{6} Setting Maximum Motor No.2 Speed " in the E2280 CONTROLLER Operation Manual.
Cannot set the motor speed to its maximum allowable motor rotation speed.	Either the required speed value is higher than the maximum rotation speed of the motor, or the upper limit of the rotational speed has been set in parameter P_{5} or P_{6} .	Set the Maximum Rotation Speed to a value less than the Motor Rotation Speed set in Parameter P_{5} or P_{6} . Refer to " 18 - 4 ⑤ P_{5} Setting Maximum Motor No. 1 Speed " of the E2280 CONTROLLER Operation Manual. Refer to " 18 - 4 ⑥ P_{6} Setting Maximum Motor No. 2 Speed " of the E2280 CONTROLLER Operation Manual.
	Air Input Monitoring Override (P_{9} parameter) is set to \square and the motor's maximum speed has been limited to 30,000min ⁻¹ (rpm).	Check the setting of parameter . (Refer to " 18 - 4 ⑨ P_{9} Selection of Air Input Monitoring Override " of the E2280 CONTROLLER Operation Manual).
Overheating during rotation.	Cutting debris has contaminated the ball bearings, damaging the ball bearings.	Replace the ball bearings. (Return to NAKANISHI dealer service.)
	Low air pressure.	Check air hose connection at the motor for air pressure.

Refer to the spindle and the E2280 CONTROLLER Operation Manuals.

10. DISPOSAL OF THE BRUSHLESS MOTOR

When disposal of a Brushless Motor is necessary, follow the instructions from your local government agency for proper disposal of industrial components.