

MO 4 OO OO



NAKANISHI INC.

Headquarters · Factory
700 Shimohinata, Kanuma, Tochigi 322-8666, Japan
TEL: +81-289-64-3520 / FAX: +81-289-62-1135

www.nakanishi-inc.com
PR-K362E Ver.2 2022-06-28 XX. ☑ XXX

SERIES E4000

ULTRA-HIGH-SPEED & SUPER-PRECISION

Little Giant

This little spindle brings you a giant profit

✓ The Strongest Spindle in its Ø40mm class

- Max power 1,200W
- E4000 torque is 10 times as big as E3000
BMS-4020 (100cN·m), EMS-3060K (10cN·m)

✓ Spindle accuracy within 1 μm

- Optimum for high-precision machining
- Longer tool life

✓ Ceramic Bearing

- Higher rigidity for heavy cutting
- Longer bearing life

✓ Brushless motor

- No need to replace carbon brushes
to enable maintenance-free operation
- Carbon brush dust will no longer penetrate
the bearing to extend the product life

E4000 & E3000 torque curve comparison

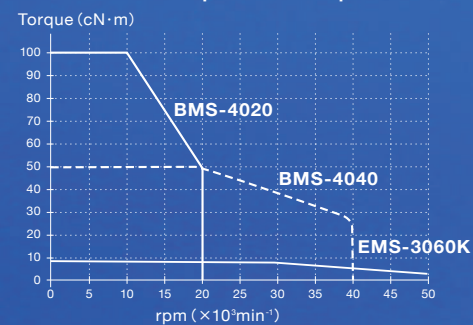

Index

Spindle (Modular type)

- NR4040-AQC** Air quick change spindle p.7
Max.rpm 40,000min⁻¹
- NRR4040-QC** Lever quick change spindle p.9
Max.rpm 40,000min⁻¹
- NR-4040** Straight type p.11
Max.rpm 40,000min⁻¹

Motor (Modular type)

- EM-4020** Straight cord type p.13
1,000 ~ 20,000min⁻¹
- EM-4020A** Angle cord type p.13
1,000 ~ 20,000min⁻¹
- EM-4040** Straight cord type p.13
1,000 ~ 40,000min⁻¹
- EM-4040A** Angle cord type p.13
1,000 ~ 40,000min⁻¹

Motor Spindle (One-piece type)

- BMS-4020 / BMS-4020 2M** Straight cord type p.17
Max.rpm 20,000min⁻¹
- BMS-4020RA** Angle cord type p.17
Max.rpm 20,000min⁻¹
- BMS-4040 / BMS-4040 2M** Straight cord type p.19
Max.rpm 40,000min⁻¹
- BMS-4040RA** Angle cord type p.19
Max.rpm 40,000min⁻¹
- BMS-4040-RGD-03M / BMS-4040-RGD-2M** Straight cord type p.21
Max.rpm 40,000min⁻¹
- BMS-4040RA-RGD-03M / BMS-4040RA-RGD-2M** Angle cord type p.21
Max.rpm 40,000min⁻¹
- BMS-4020-MQL / BMS-4020-MQL-2M** Coolant through spindle p.23
Max.rpm 20,000min⁻¹
- BMS-4040-MQL / BMS-4040-MQL-2M** Coolant through spindle p.23
Max.rpm 40,000min⁻¹
- BMS-4020-MQL-CHK / BMS-4020-MQL-CHK-2M** Coolant through spindle p.25
Max.rpm 20,000min⁻¹
- BMS-4040-MQL-CHK / BMS-4040-MQL-CHK-2M** Coolant through spindle p.25
Max.rpm 40,000min⁻¹

Controller

- E4000 CONTROLLER** p.27
Controller

Air line kit

- AL-C1204** p.28
Air line kit

Motor cord

- Power cable with Air hose**
[Length] 2m, 4m, 6m, 8m
- EMCD-4000** Joint type motor cord p.27
- Signal cable**
[Length] 2m, 4m, 6m, 8m
- EMCD-4000S** Joint type motor cord p.27

Accessories

- E4000-PB** p.28
Box for control panel
- E4000-SRB** p.28
Safety relay box
- GR-40** p.28
Grip ring
- CH16 / CH160H / CHK / CHK-OH** p.29
Collet
- QC5-16-R / QC5-K / QC5-K-R** p.29
Collet holder

System Chart

Modular type ø40mm

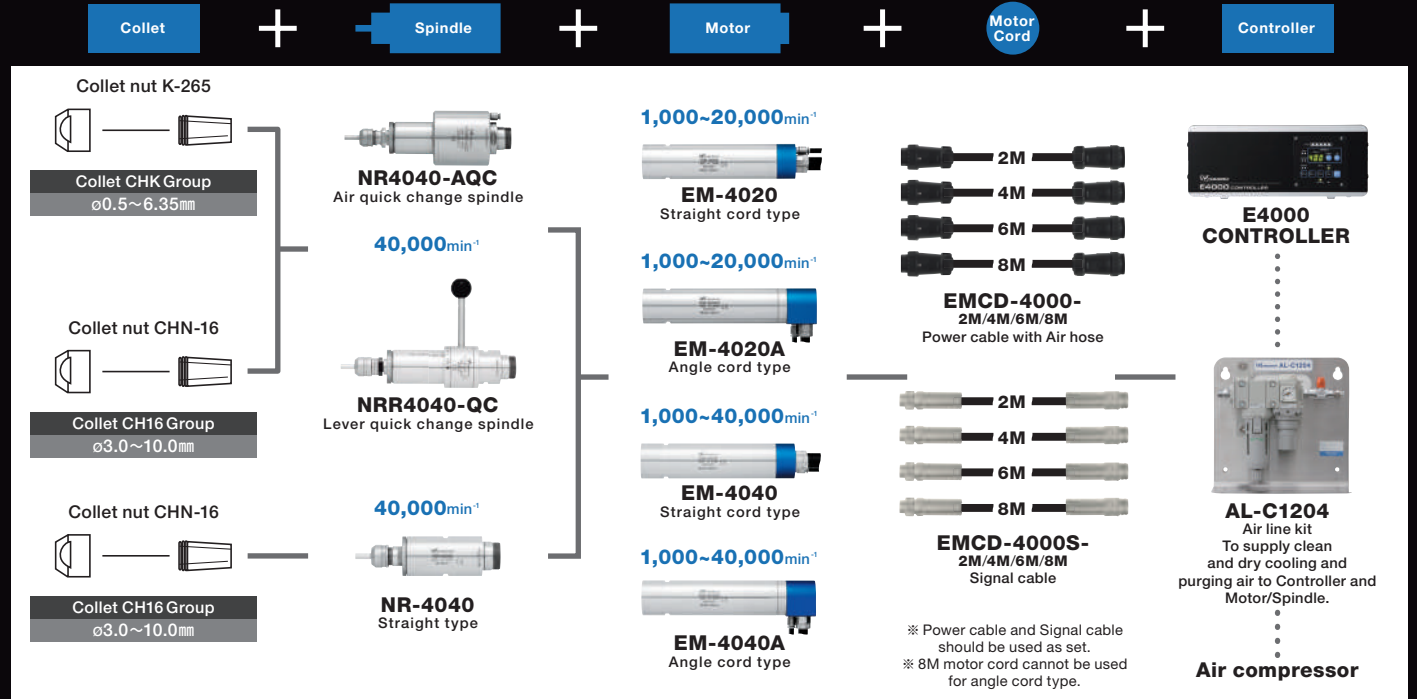

One-piece type ø40mm

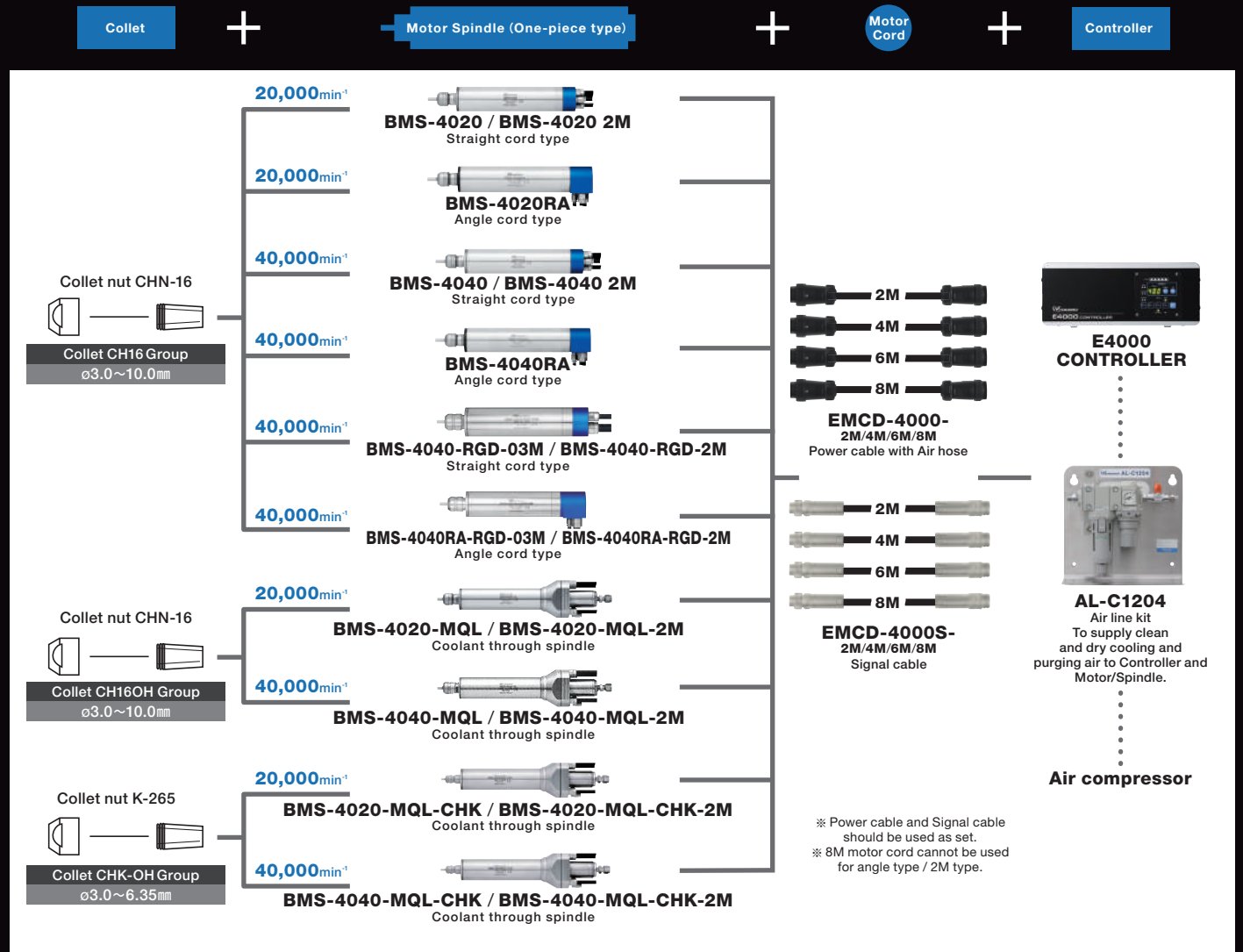

Shown In Actual Size

Spindle (Modular type)



40 **NRR4040-QC**
p.9



40 **NR-4040**
p.11



40 **NR4040-AQC**
p.7



40 **EM-4020**
p.13

40 **EM-4040**
p.13



Spindle Guide

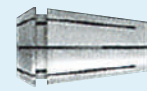

CH16 / CHK



QC5-16/QC5-16-R/QC5-K/QC5-K-R



NR4040-AQC

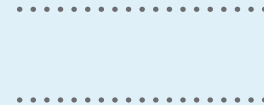

EM-4020 / EM-4040

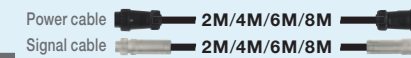
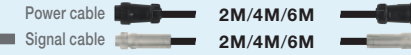

EM-4020A / EM-4040A

Power cable 2M/4M/6M/8M
Signal cable 2M/4M/6M/8MPower cable 2M/4M/6M
Signal cable 2M/4M/6M

E4000 CONTROLLER



AL-C1204

E4000 SERIES

Spindle (Modular type)

NR4040-AQC

Air quick change spindle

- Auto Tool Change with *BT5 collet holder. *Original
- Enhancing productivity by enabling external tool set-up.
- 2 types of collet holders are available. (CH16 and CHK)

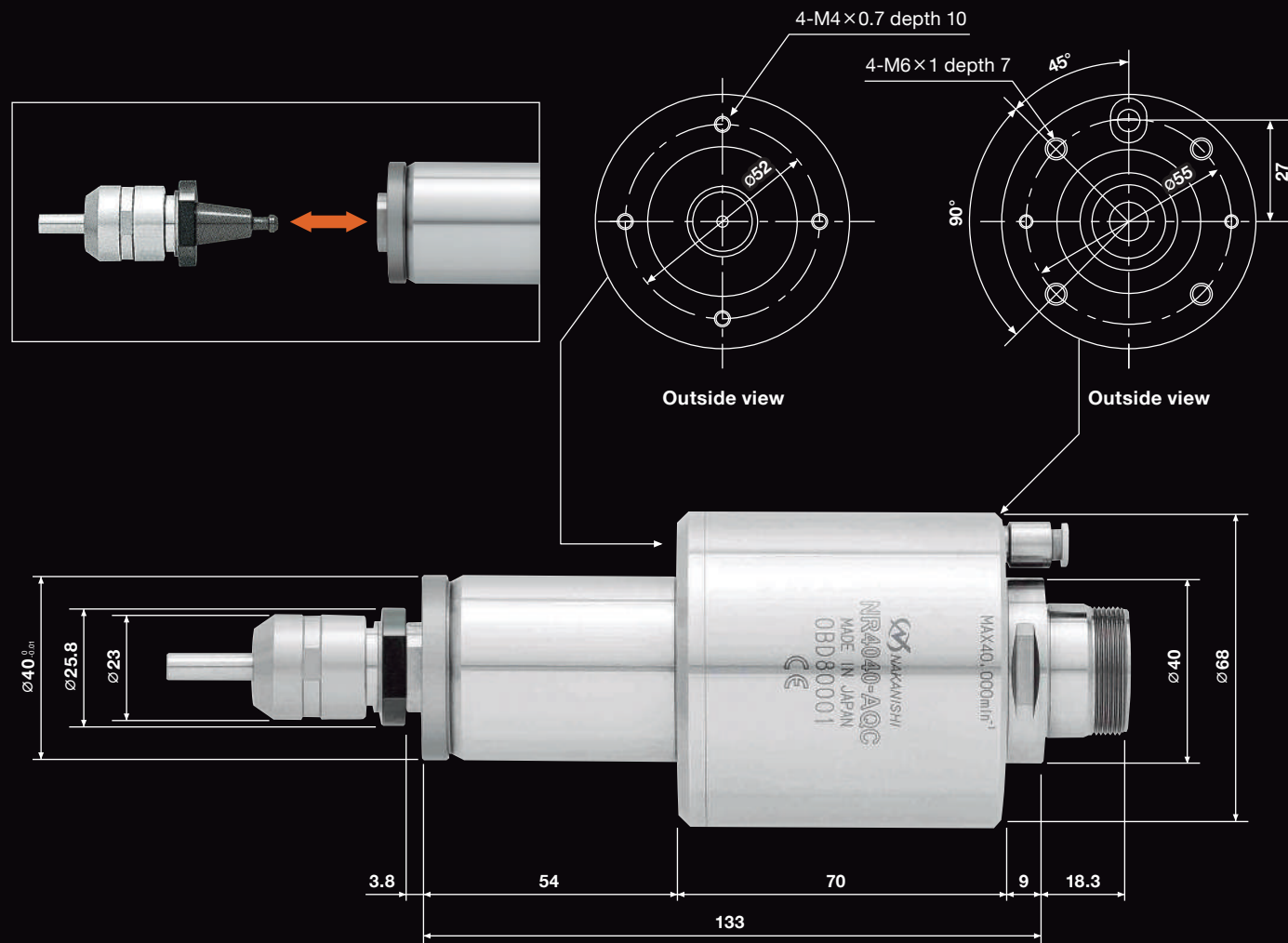
O.D. ϕ 40mm

Outside view of the tip of the spindle

■ QC5-16
(Collet holder for collet CH16)
When mounting

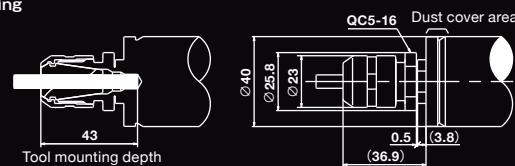

■ QC5-K
(Collet holder for collet CHK)
When mounting

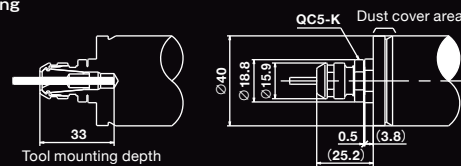

Specifications

DXF data DXF files are available on our website

Order by Code No.

NR4040-AQC

Code No. **9219** Model **NR4040-AQC**

O.D.	Spindle Accuracy	Max. rpm	Air for collet opening	Weight
ϕ 40mm	Within $1\mu\text{m}$	40,000min ⁻¹	0.55 ~ 0.6MPa	2,160g
Motors			Collet holders	
EM-4020 · EM-4020A · EM-4040 · EM-4040A			QC5-16 / QC5-16-R (For collet CH16)	QC5-K / QC5-K-R (For collet CHK)

Standard Accessories Wrench (36) : 1pc. / Air hose with filter (K-251) : ϕ 6mm x 2m

Parts (Optional)

Collet	You can choose the I.D. size (The following is an example of ϕ 6.0mm.)		Collet holder (With collet nut)	Wrench	
			QC5-16/K QC5-16/K-R		
			* In case using a Preset adapter, QC5-16/K is needed.		
CH16	Code No.	931 6 0	9216	9225	2083
	I.D.	ϕ 3.0mm~10.0mm p.29	QC5-16 (For collet CH16)	QC5-16-R (For collet CH16)	Wrench 17 x 22 (2pcs.)
	Model	CH16- 6 . 0 (I.D. ϕ 6.0mm)			
CHK	Code No.	915 6 0	9215	9224	2026
	I.D.	ϕ 0.5mm~6.35mm p.29	QC5-K (For collet CHK)	QC5-K-R (For collet CHK)	Wrench 12 x 14 (2pcs.)
	Model	CHK- 6 . 0 (I.D. ϕ 6.0mm)			

In case using a Preset adapter, only 1pc. wrench is used.
CH16 collet → 17 x 22 wrench (1pc.) / CHK collet → 12 x 14 wrench (1pc.)

Preset adapter (QC5-16/QC5-K)

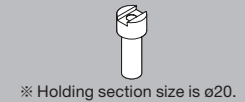
* Holding section size is ϕ 20.

Code No.	9218
Model	QC5-16 ADP (For collet QC5-16)

Code No.	9217
Model	QC5-K ADP (For collet QC5-K)

Set-up outside machines

In case using a milling holder

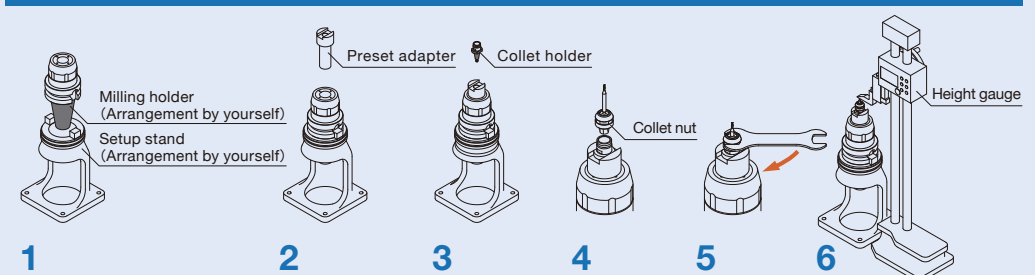

Set-up outside machines

In case using a vice

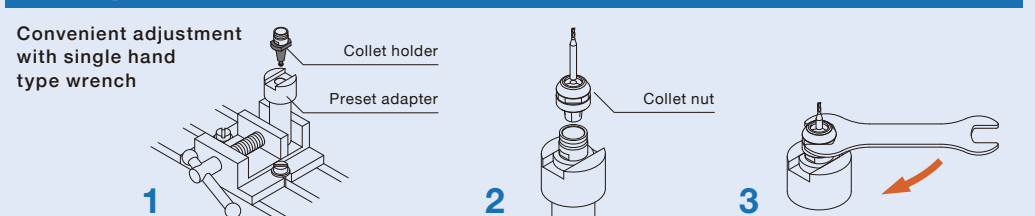

Spindle Guide

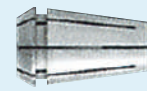

CH16 / CHK



QC5-16/QC5-16-R/QC5-K/QC5-K-R

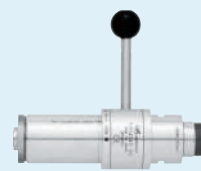

NRR4040-QC

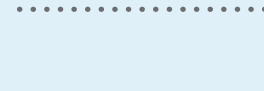

EM-4020 / EM-4040

EM-4020A / EM-4040A

Power cable 2M/4M/6M/8M

Signal cable 2M/4M/6M/8M

EMCD-4000 / EMCD-4000S

Power cable 2M/4M/6M

Signal cable 2M/4M/6M

EMCD-4000 / EMCD-4000S



E4000 CONTROLLER



AL-C1204

E4000 SERIES

Spindle (Modular type)

NRR4040-QC

Lever quick change spindle

※Outside view : with QC5-16 collet holder

- Quick and easy tool change with *BT5 collet holder by lever chucking system. ※Original
- Improvement of adjustment process by setting collet in advance.
- 2 types of collet holders are available. (CH16 and CHK)

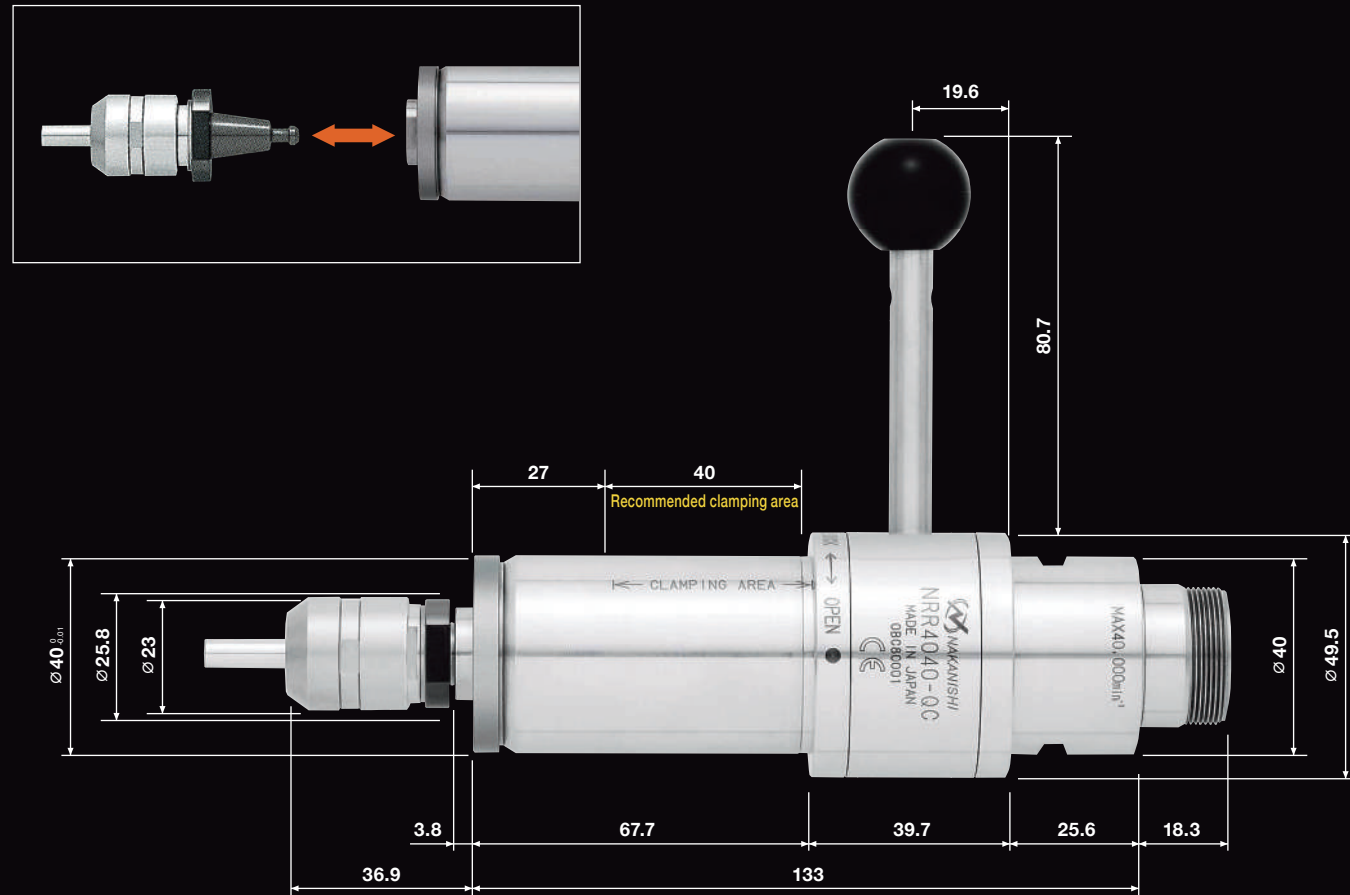
O.D. ϕ 40mm

Outside view of the tip of the spindle

■ QC5-16
(Collet holder for collet CH16)
When mounting

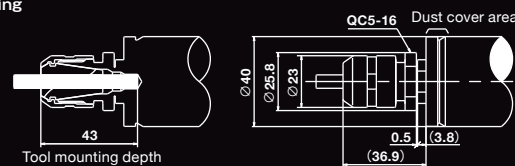

■ QC5-K
(Collet holder for collet CHK)
When mounting

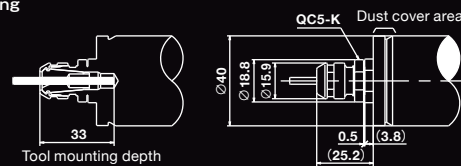

Specifications

DXF data DXF files are available on our website

Order by Code No.

NRR4040-QC

Code No. **9214**Model **NRR4040-QC**

O.D.	Spindle Accuracy	Max. rpm	Lever operating angle	Weight
ϕ 40mm	Within $1\mu\text{m}$	40,000min ⁻¹	90°	1,300g
Motors			Collet holders	
EM-4020 · EM-4020A · EM-4040 · EM-4040A			QC5-16 / QC5-16-R (For collet CH16)	QC5-K / QC5-K-R (For collet CHK)

Standard Accessories Wrench (36) : 1pc.

Parts (Optional)

Collet	You can choose the I.D. size (The following is an example of ϕ 6.0mm.)		Collet holder (With collet nut)		Wrench
			QC5-16/K	QC5-16/K-R	
CH16	Code No.	931 6 0	9216	9225	2083
I.D. ϕ 3.0mm~10.0mm p.29	Model	CH16- 6 . 0 (I.D. ϕ 6.0mm)	QC5-16 (For collet CH16)	QC5-16-R (For collet CH16)	Wrench 17 × 22 (2pcs.)
CHK	Code No.	915 6 0	9215	9224	2026
I.D. ϕ 0.5mm~6.35mm p.29	Model	CHK- 6 . 0 (I.D. ϕ 6.0mm)	QC5-K (For collet CHK)	QC5-K-R (For collet CHK)	Wrench 12 × 14 (2pcs.)

In case using a Preset adapter, only 1pc. wrench is used.
CH16 collet → 17 × 22 wrench (1pc.) / CHK collet → 12 × 14 wrench (1pc.)

Preset adapter (QC5-16/QC5-K)

※ Holding section size is ϕ 20.

Code No. **9218**Model **QC5-16 ADP**
(For collet QC5-16)Code No. **9217**Model **QC5-K ADP**
(For collet QC5-K)

Set-up outside machines

In case using a milling holder

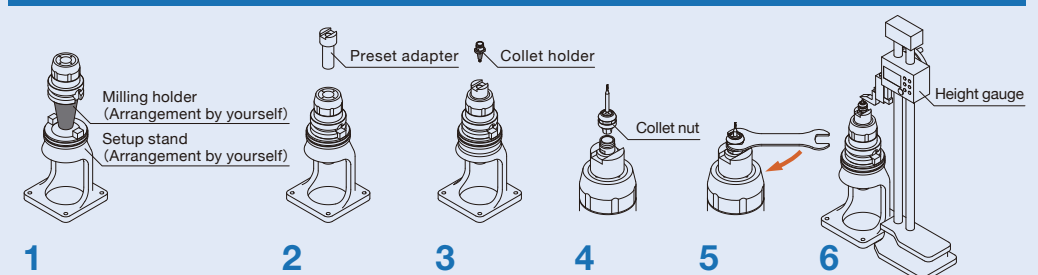

Set-up outside machines

In case using a vice

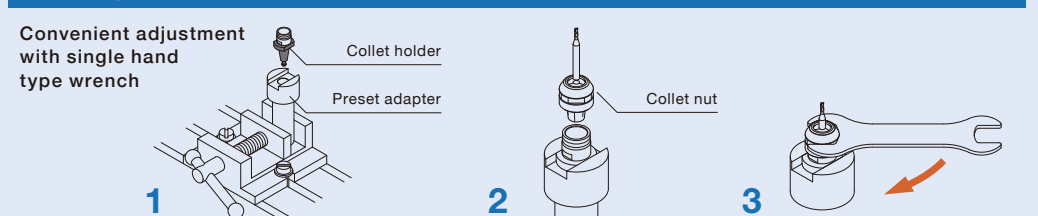

Spindle
Guide

NR-4040

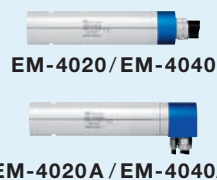

EM-4020/EM-4040

EM-4020A/EM-4040A

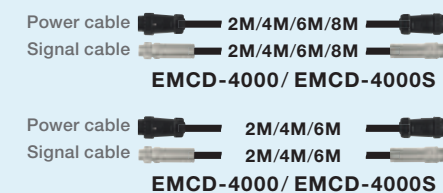
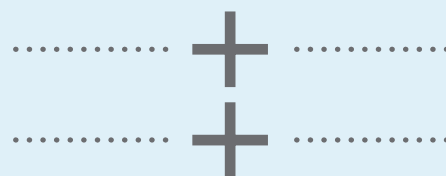

E4000 CONTROLLER



AL-C1204

E4000 SERIES

Spindle (Modular type)

NR-4040

Straight type

※1:In case for the shank size less than $\phi 6.9\text{mm}$
 ※2:In case for the shank $\phi 6.9\text{mm}$ or more

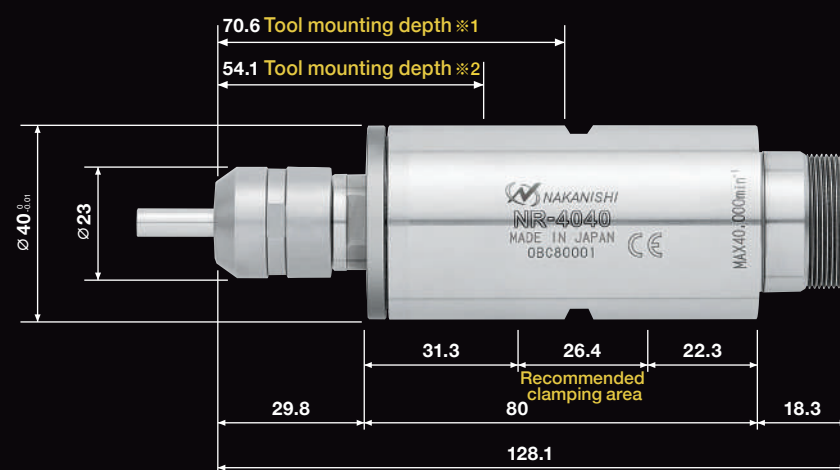
O.D. $\phi 40\text{mm}$ 

Specifications

DXF data DXF files are available on our website

Order by Code No.

NR-4040

Code No.

7902

Model

NR-4040

O.D.	Spindle Accuracy	Collet	Max. rpm	Motors	Weight
$\phi 40\text{mm}$	Within $1\mu\text{m}$	CH16 Group ($\phi 3.0 \sim \phi 10.0\text{mm}$)	40,000min ⁻¹	EM-4020 · EM-4020A EM-4040 · EM-4040A	700g
Standard Accessories		Collet nut (CHN-16) / Wrench (17 × 22) : 2pcs. · (36) : 1pc.			
Options		Collet (CH16 Group) : $\phi 3.0\text{mm} \sim \phi 10.0\text{mm}$ p.29			

* Collet is sold separately.

Motor (Modular type)

Order by Code No.

EM-4020 (20,000rpm) Straight cord type



EM-4020A (20,000rpm) Angle cord type



EM-4040 (40,000rpm) Straight cord type



EM-4040A (40,000rpm) Angle cord type



Specifications

DXF data DXF files are available on our website

EM-4020

Code No. **8348** Model **EM-4020**

O.D.	Rpm	Max. power	
Ø40mm	1,000~20,000min ⁻¹	1,200w	
Cord length	Min. Bending Cord Radius	Max. torque	Weight
0.3m	70mm	1.0N·m	1,300g
Standard Accessories Wrench (36) : 1pc.			
Specifications Air pressure : 0.35MPa / Max. Air consumption : 100Nℓ / min Power cable with Air hose : Connector Diameter : ø30mm / Air hose : ø6mm Signal cable : Connector Diameter : ø16mm			
Options Power cable with Air hose : Length 2m (9253), 4m (9254), 6m (9255), 8m (9256) Signal cable : Length 2m (9257), 4m (9258), 6m (9259), 8m (9260)			

EM-4020A

Code No. **8349** Model **EM-4020A**

O.D.	Rpm	Max. power	
Ø40mm	1,000~20,000min ⁻¹	1,200w	
Cord length	Min. Bending Cord Radius	Max. torque	Weight
2.0m	70mm	1.0N·m	1,800g
Standard Accessories Wrench (36) : 1pc.			
Specifications Air pressure : 0.35MPa / Max. Air consumption : 100Nℓ / min Power cable with Air hose : Connector Diameter : ø30mm / Air hose : ø6mm Signal cable : Connector Diameter : ø16mm			
Options Power cable with Air hose : Length 2m (9253), 4m (9254), 6m (9255) Signal cable : Length 2m (9257), 4m (9258), 6m (9259)			

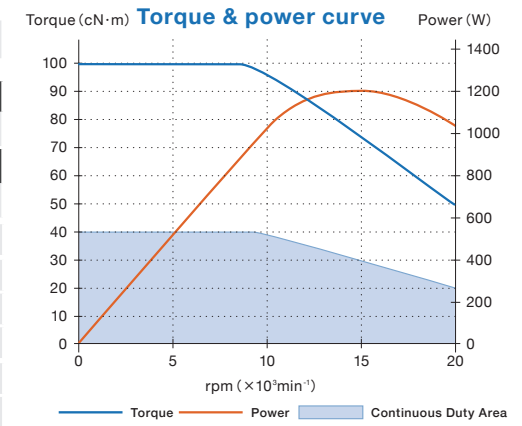

EM-4040

Code No. **8346** Model **EM-4040**

O.D.	Rpm	Max. power	
Ø40mm	1,000~40,000min ⁻¹	1,200w	
Cord length	Min. Bending Cord Radius	Max. torque	Weight
0.3m	70mm	0.5N·m	1,300g
Standard Accessories Wrench (36) : 1pc.			
Specifications Air pressure : 0.35MPa / Max. Air consumption : 100Nℓ / min Power cable with Air hose : Connector Diameter : ø30mm / Air hose : ø6mm Signal cable : Connector Diameter : ø16mm			
Options Power cable with Air hose : Length 2m (9253), 4m (9254), 6m (9255), 8m (9256) Signal cable : Length 2m (9257), 4m (9258), 6m (9259), 8m (9260)			

EM-4040A

Code No. **8347** Model **EM-4040A**

O.D.	Rpm	Max. power	
Ø40mm	1,000~40,000min ⁻¹	1,200w	
Cord length	Min. Bending Cord Radius	Max. torque	Weight
2.0m	70mm	0.5N·m	1,800g
Standard Accessories Wrench (36) : 1pc.			
Specifications Air pressure : 0.35MPa / Max. Air consumption : 100Nℓ / min Power cable with Air hose : Connector Diameter : ø30mm / Air hose : ø6mm Signal cable : Connector Diameter : ø16mm			
Options Power cable with Air hose : Length 2m (9253), 4m (9254), 6m (9255) Signal cable : Length 2m (9257), 4m (9258), 6m (9259)			

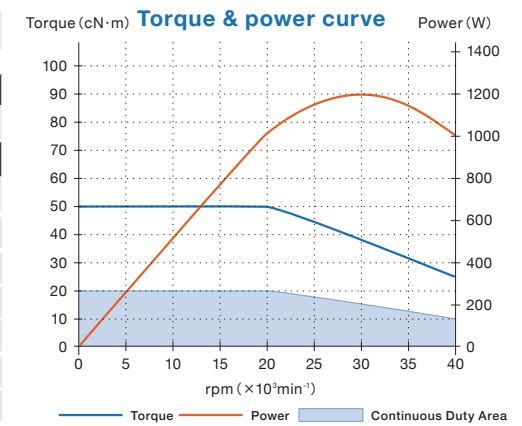

Motor Spindle (One-piece type)



40 BMS-4020RA
p.17

40 BMS-4040RA
p.19

40 BMS-4040RA-RGD-03M / BMS-4040RA-RGD-2M
p.21



40 BMS-4020 / BMS-4020 2M
p.17

40 BMS-4040 / BMS-4040 2M
p.19

40 BMS-4040-RGD-03M / BMS-4040-RGD-2M
p.21



40 BMS-4020-MQL / BMS-4020-MQL-2M
p.23

40 BMS-4040-MQL / BMS-4040-MQL-2M
p.23

40 BMS-4020-MQL-CHK / BMS-4020-MQL-CHK-2M
p.25

40 BMS-4040-MQL-CHK / BMS-4040-MQL-CHK-2M
p.25

Spindle Guide

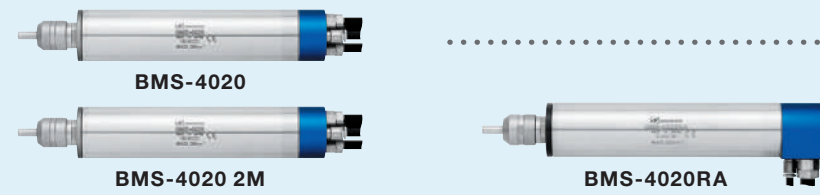

Power cable 2M/4M/6M/8M
Signal cable 2M/4M/6M/8M
EMCD-4000/ EMCD-4000S

Power cable 2M/4M/6M
Signal cable 2M/4M/6M
EMCD-4000/ EMCD-4000S



E4000 SERIES

Motor Spindle (One-piece type)

BMS-4020 / BMS-4020 2M

Straight cord type

※1:In case for the shank size less than ø6.9mm ※2:In case for the shank ø6.9mm or more



O.D. ø40mm



Specifications

DXF data DXF files are available on our website

Order by Code No.

BMS-4020 / BMS-4020 2M

Code No.	7803	Model	BMS-4020
Code No.	7805	Model	BMS-4020 2M

O.D.	Max. rpm	Spindle Accuracy	Collet	Max. power
ø40mm	20,000min ⁻¹	Within1μm	CH16Group (ø3.0 ~ ø10.0mm)	1,200w
Cord length	Min. Bending Cord Radius	Max. torque	Weight	
BMS-4020 : 0.3m BMS-4020 2M : 2.0m	70mm	1.0N·m	BMS-4020 : 1.5kg BMS-4020 2M : 2.0kg	
Standard Accessories Collet nut (CHN-16) / Wrench (17 × 22) : 2pcs.				
Specifications Air pressure : 0.35MPa / Max. Air consumption : 100Nℓ / min Power cable with Air hose : Connector Diameter : ø30mm / Air hose : ø6mm Signal cable : Connector Diameter : ø16mm				
Options Collet (CH16 Group) : ø3.0 ~ ø10.0mm p.29 Power cable with Air hose : Length 2m (9253), 4m (9254), 6m (9255), 8m (9256) Signal cable : Length 2m (9257), 4m (9258), 6m (9259), 8m (9260)				

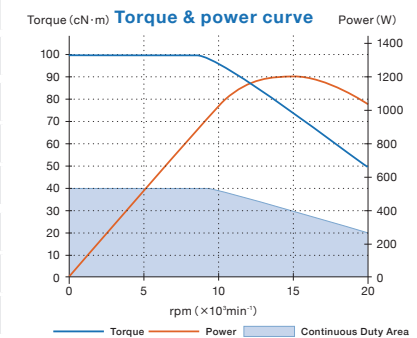

※ 8M motor cord cannot be used for BMS-4020 2M.
※ Collet is sold separately.

BMS-4020RA

Angle cord type

※1:In case for the shank size less than ø6.9mm ※2:In case for the shank ø6.9mm or more



O.D. ø40mm



BMS-4020RA

Code No.	7804	Model	BMS-4020RA
----------	-------------	-------	------------

O.D.	Max. rpm	Spindle Accuracy	Collet	Max. power
ø40mm	20,000min ⁻¹	Within1μm	CH16Group (ø3.0 ~ ø10.0mm)	1,200w
Cord length	Min. Bending Cord Radius	Max. torque	Weight	
2.0m	70mm	1.0N·m	2.0kg	
Standard Accessories Collet nut (CHN-16) / Wrench (17 × 22) : 2pcs.				
Specifications Air pressure : 0.35MPa / Max. Air consumption : 100Nℓ / min Power cable with Air hose : Connector Diameter : ø30mm / Air hose : ø6mm Signal cable : Connector Diameter : ø16mm				
Options Collet (CH16 Group) : ø3.0 ~ ø10.0mm p.29 Power cable with Air hose : Length 2m (9253), 4m (9254), 6m (9255) Signal cable : Length 2m (9257), 4m (9258), 6m (9259)				

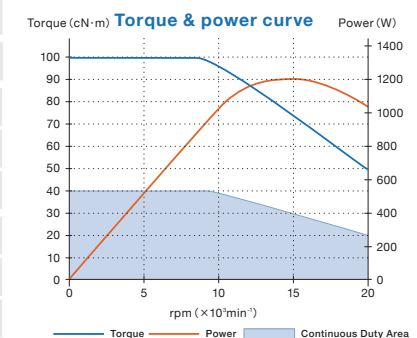

※ Collet is sold separately.

Spindle Guide

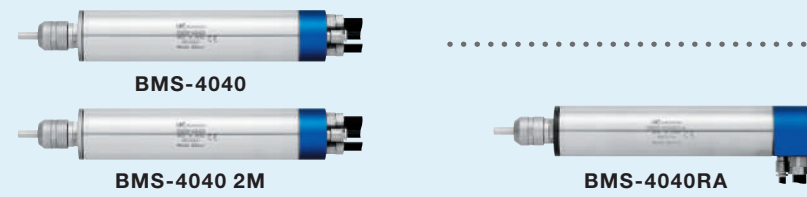

Power cable: 2M/4M/6M/8M
Signal cable: 2M/4M/6M/8M
EMCD-4000/ EMCD-4000S

Power cable: 2M/4M/6M
Signal cable: 2M/4M/6M
EMCD-4000/ EMCD-4000S



E4000 SERIES

Motor Spindle (One-piece type)

BMS-4040 / BMS-4040 2M

Straight cord type

※1:In case for the shank size less than ø6.9mm ※2:In case for the shank ø6.9mm or more



O.D. ø40mm



Specifications

DXF data DXF files are available on our website

Order by Code No.

BMS-4040 / BMS-4040 2M

Code No.	7806	Model	BMS-4040
Code No.	7809	Model	BMS-4040 2M



O.D.	Max. rpm	Spindle Accuracy	Collet	Max. power
ø40mm	40,000min ⁻¹	Within1μm	CH16Group (ø3.0 ~ ø10.0mm)	1,200w
Cord length	Min. Bending Cord Radius	Max. torque	Weight	
BMS-4040: 0.3m BMS-4040 2M: 2.0m	70mm	0.5N·m	BMS-4040: 1.5kg BMS-4040 2M: 2.0kg	
Standard Accessories	Collet nut (CHN-16) / Wrench (17 × 22) : 2pcs.			
Specifications	Air pressure : 0.35MPa / Max. Air consumption : 100Nℓ / min Power cable with Air hose : Connector Diameter : ø30mm / Air hose : ø6mm Signal cable : Connector Diameter : ø16mm			
Options	Collet (CH16 Group) : ø3.0 ~ ø10.0mm p.29 Power cable with Air hose : Length 2m (9253), 4m (9254), 6m (9255), 8m (9256) Signal cable : Length 2m (9257), 4m (9258), 6m (9259), 8m (9260)			

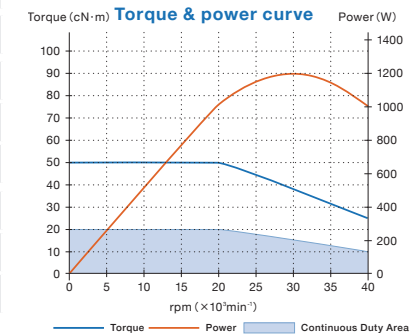

※ 8M motor cord cannot be used for BMS-4040 2M.
※ Collet is sold separately.

BMS-4040RA

Angle cord type

※1:In case for the shank size less than ø6.9mm ※2:In case for the shank ø6.9mm or more



O.D. ø40mm



BMS-4040RA

Code No.	7807	Model	BMS-4040RA
----------	-------------	-------	------------



O.D.	Max. rpm	Spindle Accuracy	Collet	Max. power
ø40mm	40,000min ⁻¹	Within1μm	CH16Group (ø3.0 ~ ø10.0mm)	1,200w
Cord length	Min. Bending Cord Radius	Max. torque	Weight	
2.0m	70mm	0.5N·m	2.0kg	
Standard Accessories	Collet nut (CHN-16) / Wrench (17 × 22) : 2pcs.			
Specifications	Air pressure : 0.35MPa / Max. Air consumption : 100Nℓ / min Power cable with Air hose : Connector Diameter : ø30mm / Air hose : ø6mm Signal cable : Connector Diameter : ø16mm			
Options	Collet (CH16 Group) : ø3.0 ~ ø10.0mm p.29 Power cable with Air hose : Length 2m (9253), 4m (9254), 6m (9255) Signal cable : Length 2m (9257), 4m (9258), 6m (9259)			

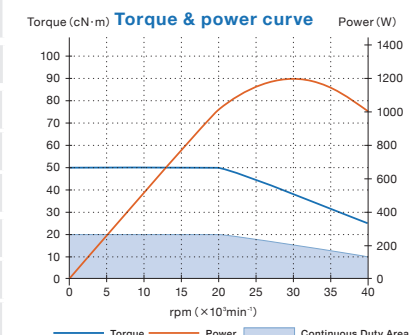

※ Collet is sold separately.

Spindle Guide



Power cable: 2M/4M/6M/8M
Signal cable: 2M/4M/6M/8M
EMCD-4000 / EMCD-4000S

Power cable: 2M/4M/6M
Signal cable: 2M/4M/6M
EMCD-4000 / EMCD-4000S



E4000 SERIES

Motor Spindle (Rigidity type)

BMS-4040-RGD-03M / BMS-4040-RGD-2M

Straight cord type

※1:In case for the shank size less than ø6.9mm ※2:In case for the shank ø6.9mm or more



O.D. ø40mm

● Twice as high rigidity as BMS-4040 in thrust and radial directions.



BMS-4040RA-RGD-03M / BMS-4040RA-RGD-2M

Angle cord type

※1:In case for the shank size less than ø6.9mm ※2:In case for the shank ø6.9mm or more



O.D. ø40mm

● Twice as high rigidity as BMS-4040 in thrust and radial directions.



Specifications

DXF data DXF files are available on our website

Order by Code No.

BMS-4040-RGD-03M / BMS-4040-RGD-2M

Code No.	7740	Model	BMS-4040-RGD-03M
Code No.	7769	Model	BMS-4040-RGD-2M



O.D.	Max. rpm	Spindle Accuracy	Collet	Max. power
ø40mm	40,000min ⁻¹	Within1μm	CH16Group (ø3.0 ~ ø10.0mm)	1,200w
Cord length	Min. Bending Cord Radius	Max. torque	Weight	
BMS-4040-RGD-03M : 0.3m BMS-4040-RGD-2M : 2.0m	70mm	0.5N·m	BMS-4040-RGD-03M : 1.4kg BMS-4040-RGD-2M : 1.9kg	

Standard Accessories	Collet nut (CHN-16) / Wrench (17 × 22) : 2pcs.
Specifications	Air pressure : 0.35MPa / Max. Air consumption : 100Nℓ / min Power cable with Air hose : Connector Diameter : ø30mm / Air hose : ø6mm Signal cable : Connector Diameter : ø16mm
Options	Collet (CH16 Group) : ø3.0 ~ ø10.0mm p.29 Power cable with Air hose : Length 2m (9253), 4m (9254), 6m (9255), 8m (9256) Signal cable : Length 2m (9257), 4m (9258), 6m (9259), 8m (9260)

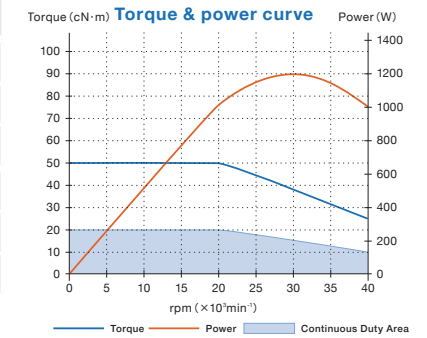

※ 8M motor cord cannot be used for BMS-4040-RGD-2M.
※ Collet is sold separately.

BMS-4040RA-RGD-03M / BMS-4040RA-RGD-2M

Code No.	7741	Model	BMS-4040RA-RGD-03M
Code No.	7770	Model	BMS-4040RA-RGD-2M



O.D.	Max. rpm	Spindle Accuracy	Collet	Max. power
ø40mm	40,000min ⁻¹	Within1μm	CH16Group (ø3.0 ~ ø10.0mm)	1,200w
Cord length	Min. Bending Cord Radius	Max. torque	Weight	
BMS-4040RA-RGD-03M : 0.3m BMS-4040RA-RGD-2M : 2.0m	70mm	0.5N·m	BMS-4040RA-RGD-03M : 1.4kg BMS-4040RA-RGD-2M : 1.9kg	

Standard Accessories	Collet nut (CHN-16) / Wrench (17 × 22) : 2pcs.
Specifications	Air pressure : 0.35MPa / Max. Air consumption : 100Nℓ / min Power cable with Air hose : Connector Diameter : ø30mm / Air hose : ø6mm Signal cable : Connector Diameter : ø16mm
Options	Collet (CH16 Group) : ø3.0 ~ ø10.0mm p.29 Power cable with Air hose : Length 2m (9253), 4m (9254), 6m (9255), 8m (9256) Signal cable : Length 2m (9257), 4m (9258), 6m (9259), 8m (9260)

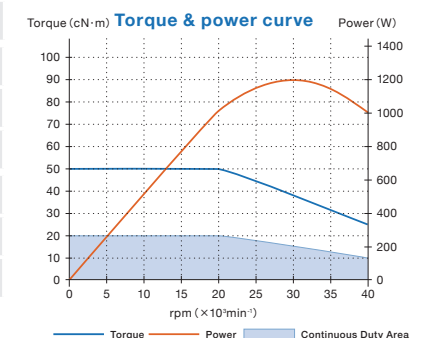

※ 8M motor cord cannot be used for BMS-4040RA-RGD-2M.
※ Collet is sold separately.

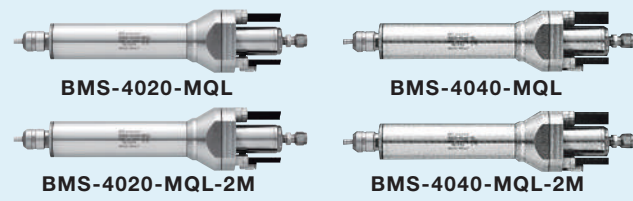

Motor Spindle (One-piece type)

! "High pressure coolant device" or "oil mist supply device" to be arranged by the customer.



Power cable 2M/4M/6M/8M
Signal cable 2M/4M/6M/8M
EMCD-4000/ EMCD-4000S

Power cable 2M/4M/6M
Signal cable 2M/4M/6M
EMCD-4000/ EMCD-4000S



E4000 SERIES

Motor Spindle (One-piece type : $\phi 3.0 \sim \phi 10.0\text{mm}$)

BMS-4020-MQL / BMS-4020-MQL-2M
BMS-4040-MQL / BMS-4040-MQL-2M
Coolant through spindle



O.D. $\phi 40\text{mm}$

- Pressurized coolant entered through the back of the spindle and through the cutting tool at a speed of 40,000 RPM.
- Through coolant improves chip clearance, accuracy, productivity and extends tool-life.
- ※ "High pressure coolant device" or "oil mist supply device" to be arranged by the customer.

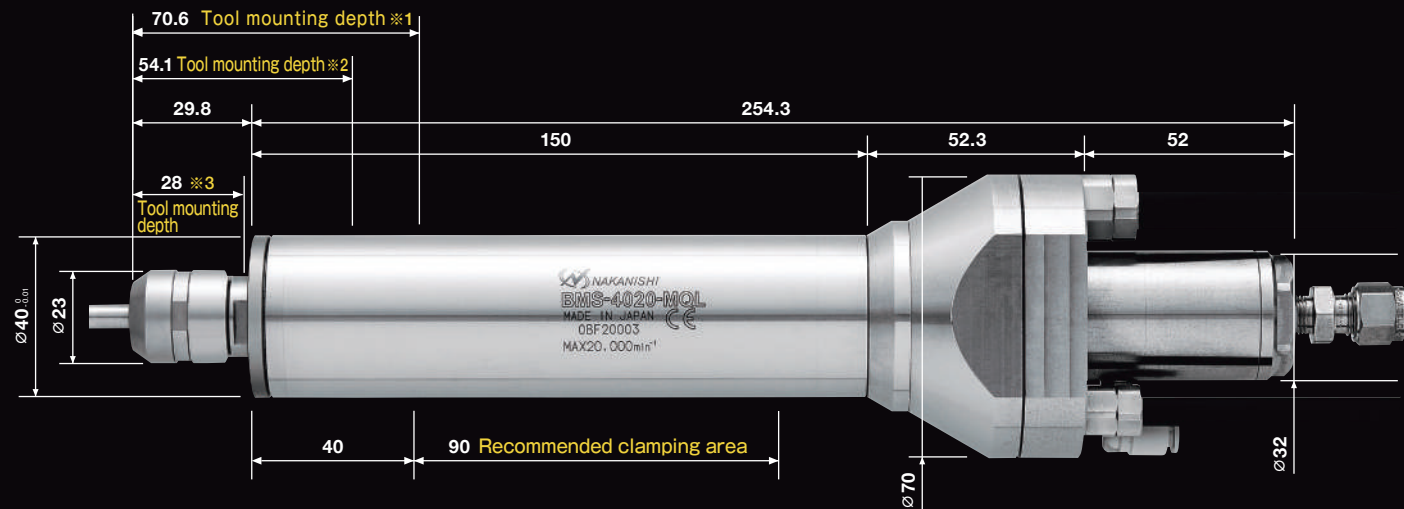
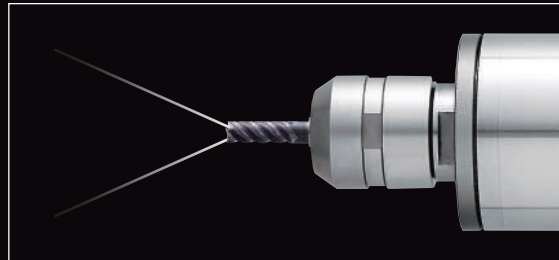

※ 1 : In case for the shank $\phi 4\text{mm}$ to less than $\phi 6.9\text{mm}$ (The shank size less than $\phi 4\text{mm}$ is through hole)
 ※ 2 : In case for the shank size $\phi 6.9\text{mm}$ or more
 ※ 3 : The tool needs to be inserted more than 28mm, or the oil leaks

Specifications

DXF data DXF files are available on our website

Order by Code No.

BMS-4020-MQL / BMS-4020-MQL-2M

Code No.	7716	Model	BMS-4020-MQL
Code No.	7717	Model	BMS-4020-MQL-2M



O.D.	Max. rpm	Spindle Accuracy	Collet	Max. power
$\phi 40\text{mm}$	20,000min ⁻¹	Within 1 μm	CH16OH Group ($\phi 3.0 \sim \phi 10.0\text{mm}$)	1,200w
Cord length		Min. Bending Cord Radius	Max. torque	Weight
BMS-4020-MQL: 0.3m BMS-4020-MQL-2M: 2.0m		70mm	1.0N·m	BMS-4020-MQL: 2.3kg BMS-4020-MQL-2M: 2.8kg
Standard Accessories		Collet nut (CHN-16) / Insert / Ferrule Set Wrench (17 × 22) : 2pcs.		
Specifications		Coolant pressure : 0.2 ~ 3.0MPa / Oil Mist pressure : 0.2 ~ 1.0MPa Power cable with Air hose : Connector Diameter : $\phi 30\text{mm}$ / Air hose : $\phi 6\text{mm}$ Signal cable : Connector Diameter : $\phi 16\text{mm}$		
Options		Collet (CH16OH Group) : $\phi 3.0 \sim \phi 10.0\text{mm}$ p.29 Power cable with Air hose : Length 2m (9253), 4m (9254), 6m (9255), 8m (9256) Signal cable : Length 2m (9257), 4m (9258), 6m (9259), 8m (9260)		

※ 8M motor cord cannot be used for BMS-4020-MQL-2M.
 ※ Collet is sold separately.

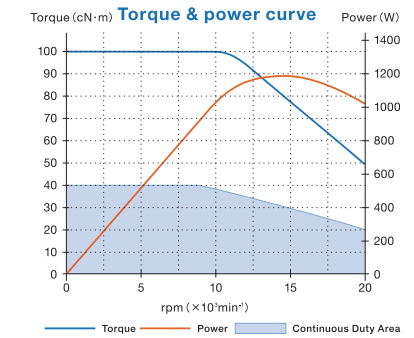

BMS-4040-MQL / BMS-4040-MQL-2M

Code No.	7714	Model	BMS-4040-MQL
Code No.	7715	Model	BMS-4040-MQL-2M



O.D.	Max. rpm	Spindle Accuracy	Collet	Max. power
$\phi 40\text{mm}$	40,000min ⁻¹	Within 1 μm	CH16OH Group ($\phi 3.0 \sim \phi 10.0\text{mm}$)	1,200w
Cord length		Min. Bending Cord Radius	Max. torque	Weight
BMS-4040-MQL: 0.3m BMS-4040-MQL-2M: 2.0m		70mm	0.5N·m	BMS-4040-MQL: 2.3kg BMS-4040-MQL-2M: 2.8kg
Standard Accessories		Collet nut (CHN-16) / Insert / Ferrule Set Wrench (17 × 22) : 2pcs.		
Specifications		Coolant pressure : 0.2 ~ 3.0MPa / Oil Mist pressure : 0.2 ~ 1.0MPa Power cable with Air hose : Connector Diameter : $\phi 30\text{mm}$ / Air hose : $\phi 6\text{mm}$ Signal cable : Connector Diameter : $\phi 16\text{mm}$		
Options		Collet (CH16OH Group) : $\phi 3.0 \sim \phi 10.0\text{mm}$ p.29 Power cable with Air hose : Length 2m (9253), 4m (9254), 6m (9255), 8m (9256) Signal cable : Length 2m (9257), 4m (9258), 6m (9259), 8m (9260)		

※ 8M motor cord cannot be used for BMS-4040-MQL-2M.
 ※ Collet is sold separately.

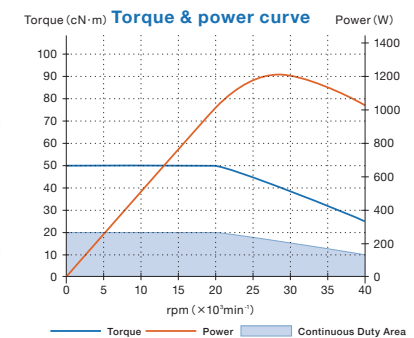

Spindle Guide

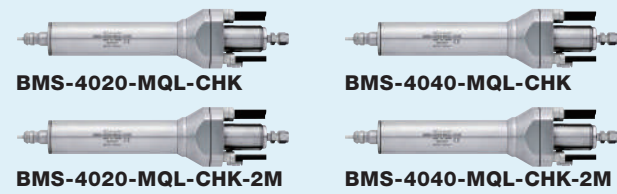

! "High pressure coolant device" or "oil mist supply device" to be arranged by the customer.

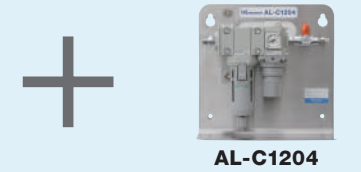
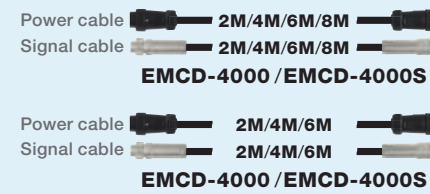

E4000 SERIES

Motor Spindle (One-piece type : $\phi 3.0 \sim \phi 6.35\text{mm}$)

BMS-4020-MQL-CHK / BMS-4020-MQL-CHK-2M
BMS-4040-MQL-CHK / BMS-4040-MQL-CHK-2M
 Coolant through spindle



- Pressurized coolant entered through the back of the spindle and through the cutting tool at a speed of 40,000 RPM.
- Through coolant improves chip clearance, accuracy, productivity and extends tool-life.
- ※ "High pressure coolant device" or "oil mist supply device" to be arranged by the customer.

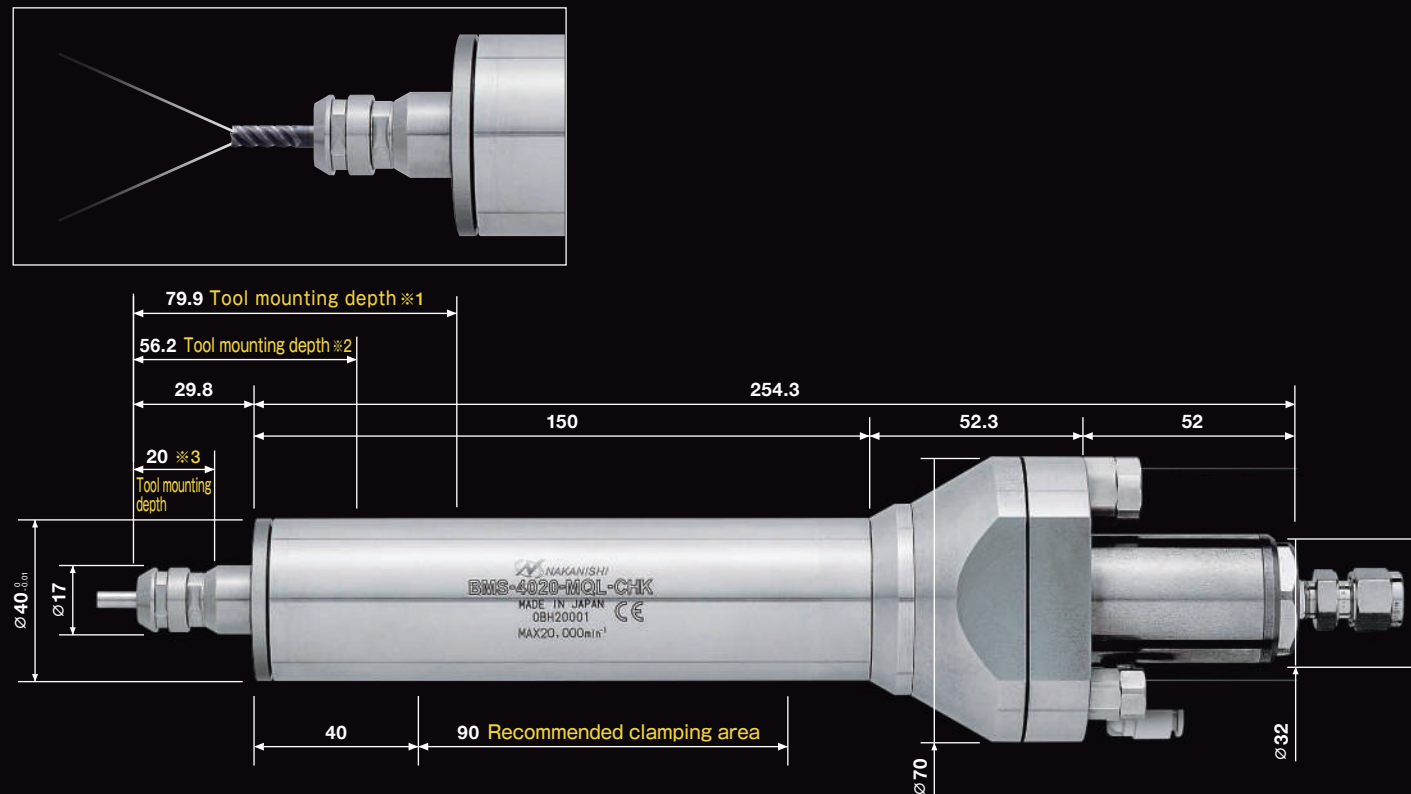

※ 1 : In case for the shank ϕ 4mm to less than ϕ 6.35mm (The shank size less than ϕ 4mm is through hole)
 ※ 2 : In case for the shank size ϕ 6.35mm
 ※ 3 : The tool needs to be inserted more than 20mm, or the oil leaks

Specifications

DXF data DXF files are available on our website

Order by Code No.

BMS-4020-MQL-CHK / BMS-4020-MQL-CHK-2M

Code No.	7735	Model	BMS-4020-MQL-CHK
Code No.	7736	Model	BMS-4020-MQL-CHK-2M



O.D.	Max. rpm	Spindle Accuracy	Collet	Max. power
$\phi 40\text{mm}$	20,000min ⁻¹	Within 1 μm	CHK-OH Group ($\phi 3.0 \sim \phi 6.35\text{mm}$)	1,200w
Cord length		Min. Bending Cord Radius	Max. torque	Weight
BMS-4020-MQL-CHK : 0.3m BMS-4020-MQL-CHK-2M : 2.0m		70mm	1.0N·m	BMS-4020-MQL-CHK : 2.3kg BMS-4020-MQL-CHK-2M : 2.8kg
Standard Accessories		Collet nut (K-265) / Insert / Ferrule Set Wrench (12 × 14) : 2pcs.		
Specifications		Coolant pressure : 0.2~3.0MPa / Oil Mist pressure : 0.2~1.0MPa Power cable with Air hose : Connector Diameter : $\phi 30\text{mm}$ / Air hose : $\phi 6\text{mm}$ Signal cable : Connector Diameter : $\phi 16\text{mm}$		
Options		Collet (CHK-OH Group) : $\phi 3.0 \sim \phi 6.35\text{mm}$ p.29 Power cable with Air hose : Length 2m (9253), 4m (9254), 6m (9255), 8m (9256) Signal cable : Length 2m (9257), 4m (9258), 6m (9259), 8m (9260) Adjuster Bolt (7739)		

※ 8M motor cord cannot be used for BMS-4020-MQL-CHK-2M.
 ※ Collet is sold separately.

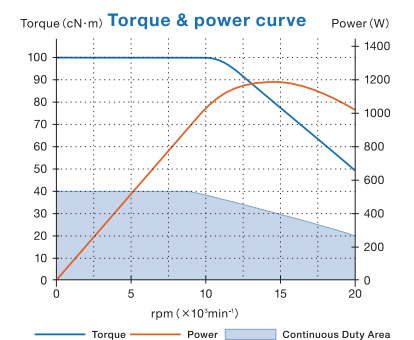

BMS-4040-MQL-CHK / BMS-4040-MQL-CHK-2M

Code No.	7737	Model	BMS-4040-MQL-CHK
Code No.	7738	Model	BMS-4040-MQL-CHK-2M



O.D.	Max. rpm	Spindle Accuracy	Collet	Max. power
$\phi 40\text{mm}$	40,000min ⁻¹	Within 1 μm	CHK-OH Group ($\phi 3.0 \sim \phi 6.35\text{mm}$)	1,200w
Cord length		Min. Bending Cord Radius	Max. torque	Weight
BMS-4040-MQL-CHK : 0.3m BMS-4040-MQL-CHK-2M : 2.0m		70mm	0.5N·m	BMS-4040-MQL-CHK : 2.3kg BMS-4040-MQL-CHK-2M : 2.8kg
Standard Accessories		Collet nut (K-265) / Insert / Ferrule Set Wrench (12×14) : 2pcs.		
Specifications		Coolant pressure : 0.2~3.0MPa / Oil Mist pressure : 0.2~1.0MPa Power cable with Air hose : Connector Diameter : $\phi 30\text{mm}$ / Air hose : $\phi 6\text{mm}$ Signal cable : Connector Diameter : $\phi 16\text{mm}$		
Options		Collet (CHK-OH Group) : $\phi 3.0 \sim \phi 6.35\text{mm}$ p.29 Power cable with Air hose : Length 2m (9253), 4m (9254), 6m (9255), 8m (9256) Signal cable : Length 2m (9257), 4m (9258), 6m (9259), 8m (9260) Adjuster Bolt (7739)		

※ 8M motor cord cannot be used for BMS-4040-MQL-CHK-2M.
 ※ Collet is sold separately.

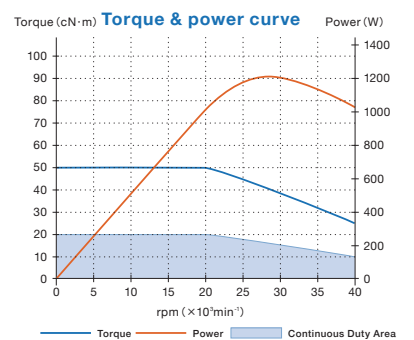

E4000 Controller / Motor cord

E4000 CONTROLLER

Controller

Code No. **8472**

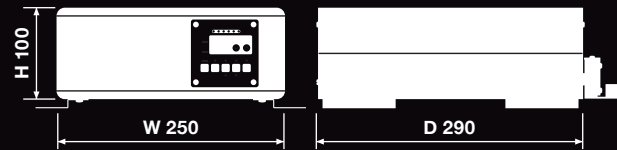

External Input / Output Control Signal Operation

- External Input
Motor Rotating / Stopped, Error Released, Rotating Direction, Motor Speed Setting and etc.
 - External Monitor
Motor Current, Error, Warning, Rotating pulse and etc.
 - Parameter Setting
Maximum motor speed setting, Fix the motor speed
- ※ For more information, please refer to the operation manual on our website.



Max. power	Input Voltage	Speed Range	Power consumption	Air consumption	Weight
1,200w	AC200~240v Without plug Multiple output power	1,000~40,000min⁻¹	3.2A	100Nℓ/min (0.2~0.35MPa)	6.7kg

Standard Accessories	Power cord : 4m / Air hose with filter(K-251:2058) : 2M / Motor connector cap(provided) Connector cover(provided) / Bracket : 4pcs. / Rubber pad : 4pcs.
----------------------	---

Motor cord	Code No.	Model	Length	Standard Accessories	Compatible model
Power cable with Air hose Connector Diameter : ϕ 30mm	9253	EMCD-4000-2M	2m	Air hose	BMS-4020-BMS-4040-BMS-4020RA BMS-4040RA-BMS-4020 2M BMS-4040 2M-EM-4020-EM-4040 EM-4020A-EM-4040A BMS-4020-MQL-BMS-4020-MQL-2M BMS-4040-MQL-BMS-4040-MQL-2M BMS-4020-MQL-CHK-BMS-4020-MQL-CHK-2M BMS-4040-MQL-CHK-BMS-4040-MQL-CHK-2M BMS-4040-RGD-03M-BMS-4040-RGD-2M BMS-4040RA-RGD-03M-BMS-4040RA-RGD-2M
	9254	EMCD-4000-4M	4m		
	9255	EMCD-4000-6M	6m		
	9256	EMCD-4000-8M	8m		
Signal cable Connector Diameter : ϕ 16mm	9257	EMCD-4000S-2M	2m	-	BMS-4020-BMS-4040-EM-4020-EM-4040 BMS-4020-MQL-BMS-4040-MQL BMS-4020-MQL-CHK-BMS-4040-MQL-CHK BMS-4040-RGD-03M-BMS-4040RA-RGD-03M
	9258	EMCD-4000S-4M	4m		
	9259	EMCD-4000S-6M	6m		
	9260	EMCD-4000S-8M	8m		
					BMS-4020-BMS-4040-EM-4020-EM-4040 BMS-4020-MQL-BMS-4040-MQL BMS-4020-MQL-CHK-BMS-4040-MQL-CHK BMS-4040-RGD-03M-BMS-4040RA-RGD-03M

※ Power cable and Signal cable should be used as set.
※ 8M motor cord cannot be used for angle cord type / 2M type.

Operation panel extension cord	Code No.	Model	Specifications	Compatible model
	8474	E4000-PEX4	Cord length : 4m Screw (M3) : 4pcs.	E4000 Controller

Accessories (Air line kit, etc.)

AL-C1204

Air line kit

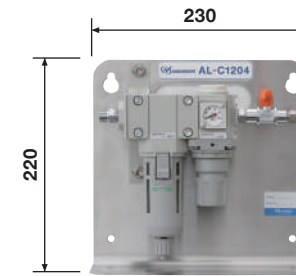

Weight:1.9kg

※ Recommendation of normal filtration rating : 0.3 μ m, Pressure range : 0.1 ~ 1.0MPa
Recommendation of air filter : M2000-WS (CKD)

Code No.	4504	Model	AL-C1204
Standard Accessories	Air filter / Air regulator / Air pressure gauge		
Compatible model	Air ON-OFF valve / Hose pipe (K-260) : 2m		

E4000-PB

Box for control panel

※ Control panel is sold separately.



Weight:216g

Code No.	8473	Model	E4000-PB
Standard Accessories	Case / Blind plate / Screw (M3) : 6pcs. / Screw (M4) : 2pcs.		
Compatible model	E4000 Controller		

E4000-SRB

Safety relay box

- Mounts directly on E4000 Controller
- Allows Emergency Stop Signal from the CNC to stop the E4000 Motor Spindle of the E4000 Controller to stop the machine operation.

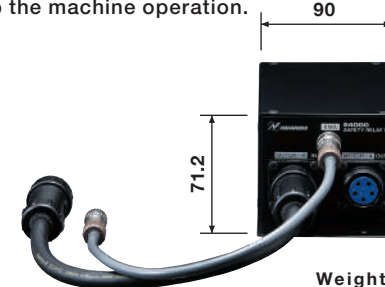

Weight:850g

Standard Accessories	Power cord : 400mm Emergency stop cord : 400mm
----------------------	---

Code No.	8475	Model	E4000-SRB
----------	-------------	-------	------------------

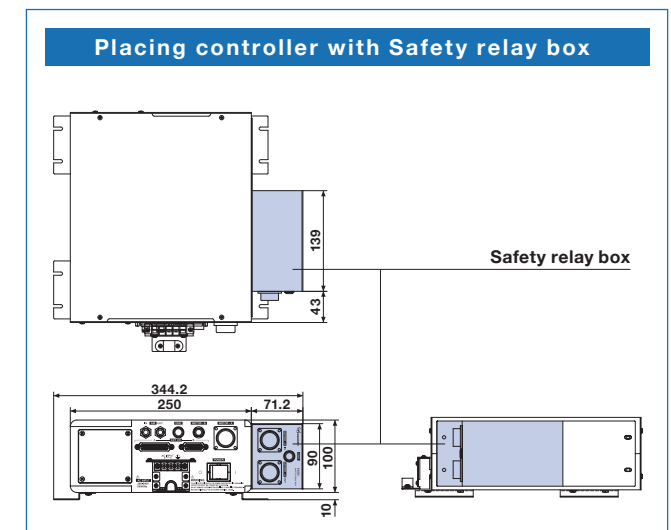

GR-40

Grip Ring

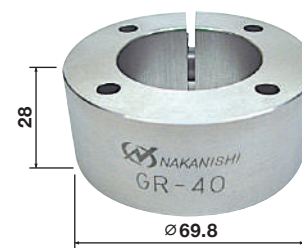

Weight:535g

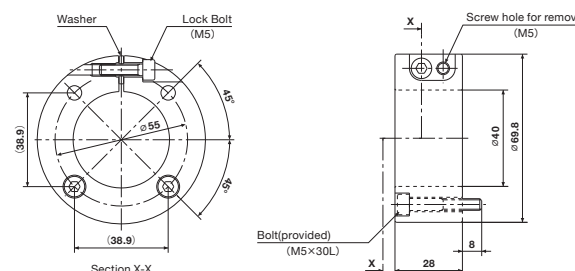

Standard Accessories	Mounting Bolt (GR-40) M5 \times 30 : 4pcs.
----------------------	--

Code No.	1886	Model	GR-40
----------	-------------	-------	--------------

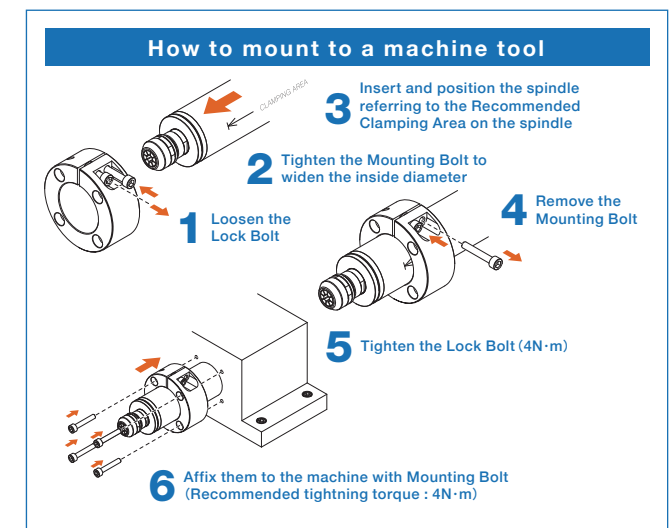

Accessories (Collet, etc.)

Collet	Code No.	Model	I.D.	Compatible model	
<p>※CH16-10.0 Length 24.5 Collet CH16 Group</p>	93130	CH16-3.0	ø3.0	BMS-4020·BMS-4040 BMS-4020 2M·BMS-4040 2M BMS-4020RA·BMS-4040RA·NR-4040 QC5-16 (NRR4040-QC) QC5-16 (NR4040-AQC) BMS-4040-RGD-03M BMS-4040-RGD-2M BMS-4040RA-RGD-03M BMS-4040RA-RGD-2M	
	93193	CH16-3.175	ø3.175		
	93140	CH16-4.0	ø4.0		
	93160	CH16-6.0	ø6.0		
	93196	CH16-6.35	ø6.35		
	93180	CH16-8.0	ø8.0		
	93100	CH16-10.0	ø10		
	93330	CH16OH-3.0	ø3.0		
	93331	CH16OH-3.175	ø3.175		
	93340	CH16OH-4.0	ø4.0		
<p>※CH16OH-9.0, 10.0 Length 24.5 Collet CH16OH Group</p>	93350	CH16OH-5.0	ø5.0	BMS-4020-MQL BMS-4040-MQL BMS-4020-MQL-2M BMS-4040-MQL-2M	
	93360	CH16OH-6.0	ø6.0		
	93363	CH16OH-6.35	ø6.35		
	93370	CH16OH-7.0	ø7.0		
	93380	CH16OH-8.0	ø8.0		
	93390	CH16OH-9.0	ø9.0		
	93400	CH16OH-10.0	ø10.0		
	91597	CHK-3.0AA	ø3.0AA※		QC5-K (NRR4040-QC) QC5-K (NR4040-AQC) ※ High precision type AA (Run-out Accuracy within 2 μm)
	91598	CHK-3.175AA	ø3.175AA※		
	91599	CHK-4.0AA	ø4.0AA※		
91600	CHK-6.0AA	ø6.0AA※			
91601	CHK-6.35AA	ø6.35AA※			
91592	CHK-2.35	ø2.35			
91530	CHK-3.0	ø3.0			
91593	CHK-3.175	ø3.175			
91540	CHK-4.0	ø4.0			
91560	CHK-6.0	ø6.0			
<p>ø1.0~ø6.35 Collet CHK Group</p>	91596	CHK-6.35	ø6.35		
			ø0.5, ø0.6, ø0.7, ø0.8, ø0.9 ø1.0, ø1.5, ø2.0, ø2.5, ø3.5, ø4.5, ø4.76, ø5.5 ø1.1, ø1.2, ø1.3, ø1.4, ø1.7, ø1.8, ø1.9, ø2.1, ø2.2, ø2.3, ø2.4, ø2.6, ø2.7, ø2.8, ø2.9, ø3.1, ø3.2, ø3.3, ø3.4, ø3.6, ø3.7, ø3.8, ø3.9, ø4.1, ø4.2, ø4.3, ø4.4, ø4.6, ø4.7, ø4.8, ø4.9, ø5.1, ø5.2, ø5.3, ø5.4, ø5.6, ø5.7, ø5.8, ø5.9 ø1.6, ø5.0		
		CHK- □□			
<p>Collet CHK-OH Group</p>	93630	CHK-OH-3.0	ø3.0	BMS-4020-MQL-CHK BMS-4020-MQL-CHK-2M BMS-4040-MQL-CHK BMS-4040-MQL-CHK-2M	
	93631	CHK-OH-3.175	ø3.175		
	93640	CHK-OH-4.0	ø4.0		
	93650	CHK-OH-5.0	ø5.0		
	93660	CHK-OH-6.0	ø6.0		
93663	CHK-OH-6.35	ø6.35			

Collet nut	Code No.	Model	Description	Compatible model
	2161	CHN-16	Collet nut for CH16 Collet	BMS-4020·BMS-4040·BMS-4020 2M BMS-4040 2M·BMS-4020RA·BMS-4040RA NR-4040·QC5-16 (NRR4040-QC) QC5-16 (NR4040-AQC) BMS-4020-MQL·BMS-4040-MQL BMS-4020-MQL-2M·BMS-4040-MQL-2M BMS-4040-RGD-03M·BMS-4040-RGD-2M BMS-4040RA-RGD-03M BMS-4040RA-RGD-2M
	2129	K-265	Collet nut for CHK Collet	
	9216	QC5-16	Collet holder for CH16 ※With CHN-16	QC5-K (NRR4040-QC) · QC5-K (NR4040-AQC) BMS-4020-MQL-CHK · BMS-4020-MQL-CHK-2M BMS-4040-MQL-CHK · BMS-4040-MQL-CHK-2M
	9225	QC5-16-R		
	9215	QC5-K	Collet holder for CHK ※With K-265	
	9224	QC5-K-R		
	9218	QC5-16 ADP	Preset adapter	QC5-16
	9217	QC5-K ADP	Preset adapter	QC5-K
	7739	ADJUSTER BOLT	Adjuster Bolt	BMS-4020-MQL-CHK BMS-4020-MQL-CHK-2M BMS-4040-MQL-CHK BMS-4040-MQL-CHK-2M

NAKANISHI Solutions LINE UP

Electric Motors & Spindles

Brushless Motors & Spindles



Application for CNC lathes / Special purpose machines

Application for machining centers and milling machines

E4000 SERIES

1,000~40,000min⁻¹ Max.1,200W
[ø40mm]

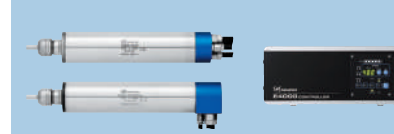

- World's highest power in this class
- Max. power: 1,200W, Max. torque: 1.0N·m

E3000 SERIES

1,000~80,000min⁻¹ Max.350W
[ø30/25/20mm]



- The largest product lines for various processing
- Space-saving solution for small CNC lathe

HES SERIES

Max.80,000min⁻¹
[For small diameter endmills and drills only]



- The most cost effective solution to add high-speed machining capability
- 80,000min⁻¹, 6.0cN·m
- BT, HSK A63, ST shanks are available
- Driven by E3000 Controller

E2000 SERIES

1,000~50,000min⁻¹ Max.200W
[ø22.8mm]



- Small size spindle allows multi-axis installation in limited space

iSpeed3 SERIES

1,000~80,000min⁻¹ Max.150W
[ø19.05/20/22mm]



- Super short motor spindle
- High efficiency brushless motor



- 50,000min⁻¹, 8.75cN·m
- BT, NT, CAT, IT, HSK A, ST shanks are available
- Driven by E3000 Controller

Air Motors & Spindles



Application for CNC lathes / Special purpose machines

Air-Speed SERIES One-piece type

Max.30,000min⁻¹ Max.130W
[ø25/23/20/19.05mm]

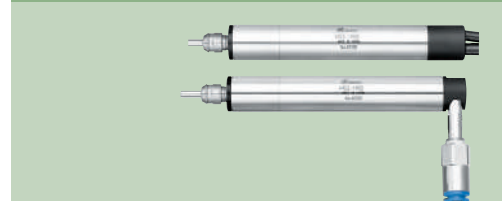

- Short body enables the spindle to mount in a limited space on a small NC/CNC lathe or on a special purpose machine

Air-Speed SERIES Modular type

Max.30,000min⁻¹ Max.130W
[ø30/25/22.8mm]



- Separate motor and spindle for flexible application changes
- Adjustable to various application through changing spindles

Air Turbine Spindles



Application for CNC lathes / Special purpose machines

Application for machining centers and milling machines

Xpeed SERIES

Max.160,000min⁻¹
[ø65/40mm]

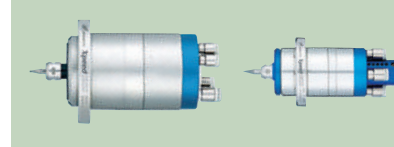

- Extreme accuracy-Runout 1μm
- For high precision small diameter drilling, internal grinding of ceramics
- Long life of spindle thanks to contactless rotation mechanism

PLANET SERIES

Max.65,000min⁻¹



- A milling machine turns into a jig grinder
- For high precision internal grinding

HTS SERIES

150,000min⁻¹
[For small diameter endmills and drills only]

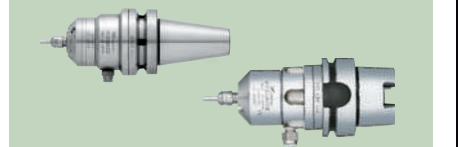

- No thermal expansion on Z axis thanks to air turbine generating little heat
- Ultra high speed 150,000min⁻¹ with higher rigidity thanks to ceramic bearings
- BT, HSK E and straight (M2040) shanks are available